

Battery-Electric Bus Implementation Report

Interim Base and Beyond



January 2020

**King County Metro Transit
Interim Base Implementation Report**

January 2020



Department of Transportation
Metro Transit Division
King Street Center, KSC-TR-0415
201 S. Jackson St
Seattle, WA 98104
206-553-3000 TTY Relay: 711
www.kingcounty.gov/metro

Alternative Formats Available
206-477-3832 TTY Relay: 711

This report was prepared by King County Metro Transit, with technical analysis and support from Center for Transportation and the Environment and input provided by representatives of the following stakeholders: Metro Staff, Metro's General Manager's office and the King County Executive.

CONTENTS

- CONTENTS I**
- EXECUTIVE SUMMARY 1**
- ADVANCING SOCIAL EQUITY AND ENVIRONMENTAL SUSTAINABILITY 2**
- BATTERY-ELECTRIC BUS TECHNOLOGY DESCRIPTION 3**
 - ENERGY 4
 - POWER 5
 - WHAT ABOUT AMPS AND VOLTS 5
- INTRODUCTION 6**
- PROCESS FOR APPROVAL OF IMPLEMENTATION REPORT AND ZERO-EMISSIONS BUS GOVERNANCE PROCESS 6**
- HISTORY 7**
 - BASE CONSTRUCTION THROUGH 2025 AND BEYOND 7
- MARKET ANALYSIS 9**
- FLEET AND PROCUREMENT 10**
 - 2019 ZERO-EMISSIONS FLEET 10
 - EARLY SHORT RANGE PROTERRA FLEET 11
 - TROLLEY BUSES 11
 - FLEET PLANNING 12
 - PROCUREMENT STRATEGY AND STANDARDS 12
- OPERATIONS 13**
- FACILITIES 15**
- CHARGING STRATEGY 16**
 - CHARGING INFRASTRUCTURE DEPLOYMENT 17
 - UTILITY RATES 19
 - UTILITY READINESS 21
 - POWER RESILIENCY 21
- IT 22**
 - VEHICLE DATA 22
 - IT PLATFORM 22
- ASSET MANAGEMENT 23**
- WORKFORCE 23**
- EQUITY AND SOCIAL JUSTICE 24**
- COMMUNITY OUTREACH 25**
- BEYOND 2025, ELECTRIFYING THE BUS BASES 25**
- EXHIBITS E-1**
 - EXHIBIT A: WORK GROUP DECISION DOCUMENTATION EA-1
 - EXHIBIT B: ZERO-EMISSIONS BUS PROGRAM GOVERNANCE EB-1
 - EXHIBIT C: PROGRAM CHARTER EC-1

EXHIBIT D: BUS PROCUREMENT PROCESS	ED-1
EXHIBIT E: FORM OF GREEN BUILDING ORDINANCE	EE-1
EXHIBIT F: COMMUNICATIONS PLAN.....	EF-1
APPENDICES.....	A-1
APPENDIX A: ELECTRIC VEHICLE CHARGING DESCRIPTION	AA-1
APPENDIX B: CONCEPTUAL INTERIM BASE LAYOUT	AB-1
APPENDIX C: POTENTIAL INTERIM BASE ROUTES	AC-1
APPENDIX D: SAE STANDARDS	AD-1
APPENDIX E: PROPOSED SOUTH ANNEX BASE CONSTRUCTION TIMELINE.....	AE-1
APPENDIX F: CHARGE ANALYSIS SUMMARY	AF-1
APPENDIX G: CHARGING INFRASTRUCTURE ILLUSTRATIONS.....	AG-1
APPENDIX H: DC-AS-A-SERVICE PRESENTATION	AH-1

EXECUTIVE SUMMARY

The King County Executive committed to County-wide emission-reduction goals in the 2015 Strategic Climate Action Plan and emission-reduction goals will continue to be a key priority in the 2020 Strategic Climate Action Plan. Since 2016 the Executive has worked with King County Metro to transition to a zero-emission fleet as efficiently as possible. King County Metro is committed to improving air quality and reducing greenhouse gas emissions from transportation by transitioning to a zero-emissions bus fleet powered by renewable energy over the next 20 years.

Moving to a fleet of battery-electric buses and retaining electric trolley buses is an essential part of King County’s strategy to combat the climate crisis and advance social equity by prioritizing the deployment of zero-emissions buses in the southern part of the county where people are disproportionately affected by pollution.

Metro will use a phased approach to acquire battery-electric buses, convert operations, prepare the workforce, and build the necessary infrastructure to support a 100 percent zero-emissions fleet by 2040. This implementation report details this transition, which will require significant renovation of Metro facilities for charging purposes, including the following:

- The process to procure 120 battery-electric buses in 2020, which will be placed into service and based at the Interim Base at South Campus the following year.
- The opening of the South Annex Base in 2025 to accommodate up to 250 battery-electric buses and provide capacity to allow for construction of infrastructure to electrify the existing South Base as early as 2033.
- The charging standards, systems, and evolving technology of battery-electric buses.
- The deployment of the charging infrastructure for battery-electric buses and Metro’s partnerships with local utilities.
- The necessary training and development of Metro’s workforce to operate and maintain battery-electric buses.

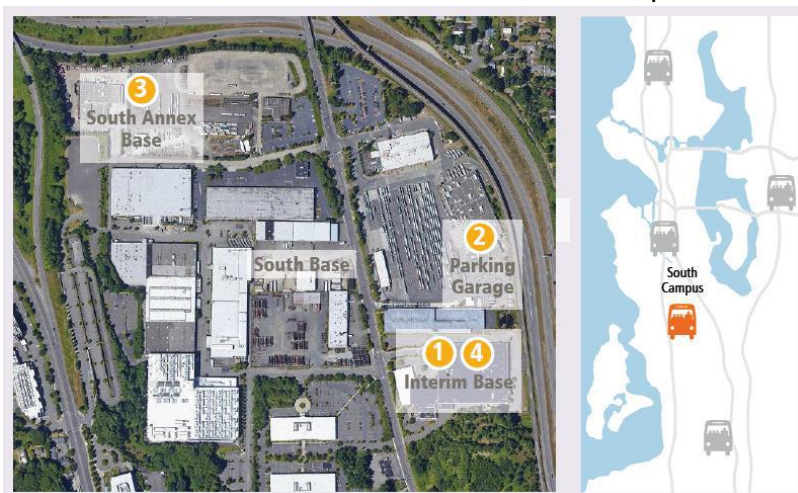

Source: Facilities Master Planning Program: Operational Capacity Growth Report Final March 2019; Figure 9: Operational Growth Strategy: South Campus

Over the next 20 years, Metro expects to have approximately 2,200 battery-electric and electric trolley buses.

ADVANCING SOCIAL EQUITY AND ENVIRONMENTAL SUSTAINABILITY

Metro will leverage its substantial investment in transitioning to a zero-emissions fleet to help achieve King County’s equity, social justice, and sustainability goals as articulated in the County’s Equity and Social Justice Ordinance and Strategic Implementation Plan and the Strategic Climate Action Plan.

In 2017, Metro pledged to transition to a zero-emissions fleet by 2040 in order to protect our climate, air quality, and health of our communities while providing safe, high-quality, efficient public transportation. Refer to page 24 for more details about Metro’s approach to implementing equity, social justice and environmental sustainability goals through zero-emissions bus service.



Source: 2020 Strategic Climate Action Plan Update
<https://www.kingcounty.gov/services/environment/climate/actions-strategies/climate-strategies/strategic-climate-action-plan/2020-SCAP-update.aspx>

BATTERY-ELECTRIC BUS TECHNOLOGY DESCRIPTION

This section was prepared by the Center for Transportation and the Environment¹ and reflects industry-wide concepts that are applicable to other transit agencies as well as King County Metro.

Battery-electric buses use energy stored in an on-board battery pack to drive an electric motor (or motors) which turns the drivetrain and propels the bus. In addition to the energy provided for propulsion, the battery system provides energy to drive electric accessories, such as the heating, ventilation, and air conditioning (HVAC) system, air compressor, and power steering pump. Inverters are used to convert current from the battery (direct current, or DC) to a form that is useable by the motor and accessories (alternating current, or AC).

A down converter is used to reduce the DC voltage for delivery to the low voltage batteries, which are used to provide small amounts of electricity required while the bus is not operating or in motion. Components such as the multiplex I/O system, cameras, Wi-Fi and farebox can draw a load even while the vehicle itself is not being powered. Furthermore, a low voltage current is also required to close the contactors to start the bus. This type of current is provided by the low-voltage batteries. A high-level schematic of the vehicle systems is provided in Figure 1.

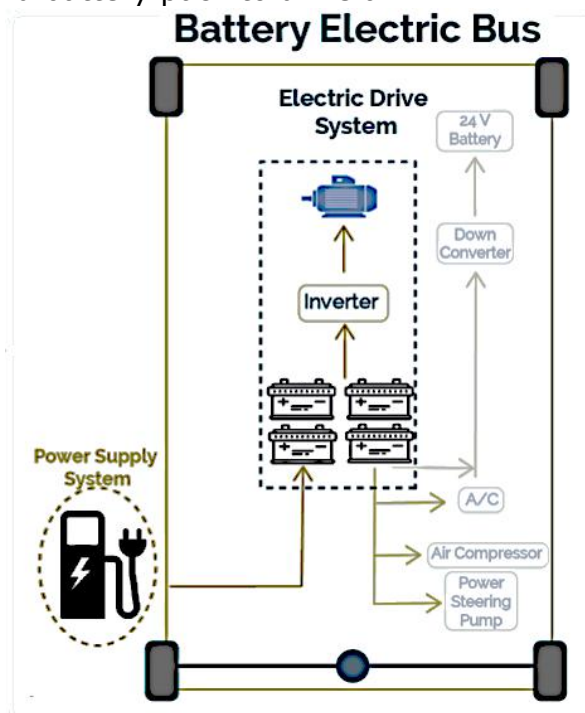

Figure 1. Basic Schematic of a Battery-Electric Bus

Unit	Describes what?	Conventional Equivalent	Example
kWh (kilowatt-hours)	Energy	Gallons (of diesel)	The bus stores 450 kWh (12 gallons diesel)
kW (kilowatts)	Power	<u>Output for Performance:</u> Horsepower	The battery pack can provide 230kW (308hp)
		<u>Input for Fueling:</u> Gallons/min	The charger can provide up to 150 kW

Table 1. Energy and Power Comparisons between Diesel and Battery-Electric Buses

¹ Visit <https://cte.tv/> for more information on the Center for Transportation and the Environment.

Unlike a conventional diesel engine or a diesel-electric hybrid where the fuel is pumped from an external source into an onboard tank, the “fuel” for a battery-electric bus is provided by the electrical grid and applied to the vehicle by a charging system. Please refer to Table 1 for a summary of the primary concepts relative to battery-electric buses. A more detailed visual explanation of these concepts can be found in Appendix A.

Energy

In a conventional diesel bus the amount of energy available on the bus is represented by the number of **gallons** of fuel in the tank. In an electric bus the amount of energy stored in the battery is represented in terms of **kilowatt-hours (kWh)**.

One limitation of today’s battery-electric buses is that they cannot store as much energy as a diesel bus. Using the example in Table 1, the equivalent of 450kWh of energy is approximately 12 gallons of diesel fuel in a conventional bus. At four miles per gallon, a diesel bus that holds 12 gallons of fuel would only be able to travel **48 miles** before needing to refuel. However, battery-electric buses are much more efficient than diesel buses. Therefore, using that same amount of energy capacity, an electric bus may be able to travel **140 miles** or more on average (depending on conditions) before needing to recharge.

However, a typical diesel bus may have a 100-gallon tank, giving it a **400-mile range** using the same assumptions. Using today’s technology, the only way to match that range (on one charge) in a battery-electric bus is to add heavier and/or more batteries. Due to weight and space considerations, adding more batteries to compensate for the difference is not a viable option. As a result, a battery-electric bus currently has a shorter operating range than its diesel counterpart. Industry research efforts continue to focus on battery density and new chemistries to address the amount of energy batteries can store. Battery density has been improving year-to-year. It is not unreasonable to expect that battery-electric buses will be able to carry more stored energy without increasing weight or limiting passenger loads in the future, further reducing the energy deficit relative to diesel buses.

“Refueling” battery-electric buses takes longer than filling a diesel tank. The time required to charge a battery-electric bus (and provide the energy to operate) will vary based on the charging technology used. Typical base charging (using pedestal mounted chargers, for example) requires the bus to be plugged in for several hours in order to be fully charged. On-route charging, also called layover charging, takes advantage of scheduled stops or layovers to restore the state of charge of the battery and therefore extending the operational range. Using layover charging, range would be governed by the number of layovers and the amount of time available to charge at each opportunity.

It is critical for transit agencies to assess how battery-electric buses will perform in service prior to deployment. Developing a deployment strategy prior to purchasing and placing buses in service allows a transit agency to make decisions about energy storage and charging options, which are two of the distinct operating characteristics of battery-electric buses. It is also important to coordinate with the utility while

developing a deployment strategy. Decisions about charging strategies will affect the time of day and amount of electricity consumed which in turn affects costs. It is important that a transit agency understand all these factors related to providing energy to the buses prior to deployment.

Power

Power describes the rate of applying or using energy over time. In a conventional diesel vehicle, a common way this is used is to express the output or “performance” of an engine in terms of horsepower. The equivalent unit of measure in electric vehicles is **kilowatts (kW)**. Power is what the battery pack can provide as an output to the vehicle for performance, such as speed and acceleration. However, power can also be used to describe the rate of energy being applied by the charger as an input into the battery to replenish it. When power is used to describe the input, the conventional equivalent is how fast a diesel pump can fill a tank (e.g. gallons/minute).

Power as an input is an important consideration during battery-electric bus operational planning because it determines the amount of time it will take to charge the battery. As discussed in relation to **Energy**, it is important to engage with the utility during planning. Depending on the power being applied by each charger and the number and type of chargers operating at the same time, it can also significantly impact the electricity bill (load or demand charges, see Section “Utility Rates”, page 19 for additional discussion).

What About Amps and Volts

Because power is an important concept, it is useful to understand what controls the amount of power that can be applied to a battery to charge it. In electrical terms, the basic equation is:

$$\text{Power} = \text{Voltage} \times \text{Current}$$

or, equivalently, in electrical units:

$$\text{Watts} = \text{Volts} \times \text{Amps}$$

Amperes, commonly Amps, is a measure of electrical current, and voltage is essentially the amount of electrical “pressure” available to move that current. Using the analogy of a water hose with an adjustable nozzle, one can think of current as the water flow through the hose, and voltage is like the amount of pressure available to spray the water when the nozzle lever is squeezed.

In the context of vehicle charging, the amount of power (rate of energy) applied is determined by both the power rating of the charger as well as the battery system that it is charging. The charger must match the battery pack’s voltage, and the current is set according to the battery’s ability to accept power. The battery pack and charger are in constant communication during charging and the battery pack will at all times limit the current from the charger based on the battery’s capability. For this reason, simply dividing the battery capacity by the charger’s power rating will not correctly predict charging times.

INTRODUCTION

In March 2017, King County Metro pledged to begin purchasing and begin placing into service battery-electric buses by 2020^{2,3} with the goal of achieving a zero-emissions bus fleet by 2040⁴. This commitment was made in support of the County's Equity and Social Justice Strategic Plan and Strategic Climate Action Plan. In the ensuing years, Metro has refined its strategy regarding the transition to a zero-emissions fleet. The following implementation report ("Implementation Report") details the process to procure 120 battery-electric buses to be based at the Interim Base at South Campus ("Interim Base") and electrification of South Annex Base at South Campus ("South Annex Base") for a capacity of up to 250 battery-electric buses.

PROCESS FOR APPROVAL OF IMPLEMENTATION REPORT AND ZERO-EMISSIONS BUS GOVERNANCE PROCESS

This Implementation Report describes decisions made by various Metro groups led by the Zero-Emissions Bus Program Group ("Program Coordination Team") during the battery-electric bus procurement process and design of Interim Base and South Annex Base. Documentation of these decisions can be found at Exhibit A. The Implementation Report was reviewed and approved by all members of the Zero-Emissions Bus Program Oversight Group. Metro's General Manager reviewed and approved the Implementation Report.

The Implementation Report is intended to be a living document that is reviewed every 12 months as battery-electric bus technology develops and base planning progresses. As necessary, Metro will update the Implementation Report to reflect decisions changing the strategy or focus of the battery-electric bus program⁵.

The Zero-Emissions Bus Program is governed by the following structure (see Exhibit B): the Strategic Program Manager for zero-emissions buses leads the staff Program Coordination Team⁶ that meets monthly to discuss and resolve issues surrounding deployment of battery-electric buses, review industry standards and provide senior management recommendations relating to those standards and Metro's deployment of battery-electric buses. Additionally, sub-groups working on utility rates, charging strategy and civil and electrical infrastructure report into the Program Coordination Team. Once a strategic decision has been made, or if the Program Coordination Team cannot reach consensus, the Zero-Emissions Bus

² King County Metro; Transit Feasibility of Achieving a Carbon- Neutral or Zero-Emission Fleet ("2017 Study")

³ This assumes that battery-electric technology develops in a way that supports transit needs.

⁴ 2017 Study.

⁵ In November 2019, the King County Council passed legislation requiring a battery-electric proviso report in September 2020. The next update of the Implementation Report will be in the form of the proviso report to Council.

⁶ The Work Group consists of: Zero-Emissions Bus Strategic Program Manager, Capital Planning, Project Delivery, Bus Procurement, Fleet Engineering, Utility Engagement Special Projects Manager, Sustainability Program Manager, Section Manager Capital Planning, Service Planning/Scheduling, Safety, Security and Training, Electrical Engineering, Power and Facilities, Bus Operations, Public Information Officer and Finance.

Program sponsor, the Capital Division Director, calls a meeting of the Zero-Emissions Bus Program Oversight Group, consisting of directors from across Metro. These meetings are used to inform senior leadership of staff recommendations and receive final approval for these decisions. The Strategic Program Manager is also a member of the Operational Capacity Growth committee and the Fleet Steering Working Group, providing communication between other key Metro initiatives. The charter guiding this work can be found at Exhibit C.

HISTORY

King County’s 2015 Strategic Climate Action Plan sets targets and priority actions for reducing emissions and increasing efficiency. The County has committed to reducing greenhouse gas emissions for its own operations by 25 percent by 2020 and 50 percent by 2030, relative to a 2007 baseline. The updated Strategic Climate Action Plan, under development for 2020, is expected to confirm or strengthen those targets. In March 2017, Metro released a report entitled “Feasibility of Achieving a Carbon-Neutral or Zero-Emission Fleet.” Metro found it could meet 70 percent of its service needs with a fleet that traveled up to 140 miles on a single charge. Through an equity impact review process Metro determined that scaling up deployment out of South Campus could advance social equity by prioritizing communities that have borne a disproportionate burden from vehicle air pollution. Metro committed to the first deployment of these buses to historically underserved populations living in the southern portion of the County.⁷

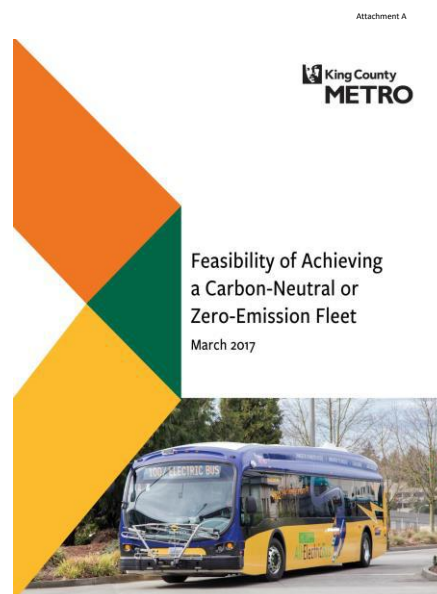

Base Construction through 2025 and Beyond⁸

In response to additional service needs and overcrowding at current bases, Metro is developing additional base capacity. The first of these bases, Interim Base, is scheduled for electrification completion in late 2021 (see Appendix B for conceptual layout drawing of Interim Base). Metro has chosen various routes (see Appendix C for potential routes, also see Figure 4 on page 14), currently operating from South Base, as the initial routes to operate from Interim Base. The Interim Base is being constructed in two phases; in 2020 the final traditional base will be constructed and used for 40 hybrid-diesel buses at opening. The second phase of Interim Base construction involves the design and electrification for the 2020 procurement of 120 electric buses, of which 100 are for regular service and the remaining 20 are

⁷ 2017 Study.

⁸ Additional detail about Metro’s base planning can be found at: <https://kingcounty.gov/~media/depts/transportation/metro/accountability/pdf/2019/metro-facilities-master-plan-operational-capacity-report.pdf>

spares⁹. Interim Base is intended as a prototype for future battery-electric bus deployment and base electrification. Metro fully expects there will be lessons learned and changes that will refine Metro processes and base design as electrification occurs across the bases and fleet.

As Metro works towards a zero-emissions fleet by 2040, the agency will convert its existing operations using a phased approach. The bases at South Campus will be electrified first to meet Metro’s equity and social justice priority to provide zero-emissions service in historically underserved communities. In 2025, the South Annex Base is scheduled to open. South Annex Base will accommodate up to 250 battery-electric buses and provide capacity to allow for construction of infrastructure to electrify the existing South Base.¹⁰ Full electrification of the South Campus could be complete in 2033. Additionally, Metro’s potential ninth base, will be sited further south and be fully electrified from its opening. The working title of this base is South King County and is scheduled for completion based on growth and replacement rates of the fleet and anticipated to be needed as early as 2030. From there, Metro will use a phased approach to electrify its other bases – with Bellevue to be the final electrified based by 2040. The preliminary base electrification schedule is provided in Table 2.

Base	Capacity Loss		Completion Year
	Year	Count (number of buses)	
Central Phase 1	2030	148	2031
Central Phase 2	2031	148	
South Base Phase 1	2032	140	2033
South Base Phase 2	2033	140	
East Base Phase 1	2034	110	2035
East Base Phase 2	2035	110	
Ryerson Phase 1	2036	103	2037
Ryerson Phase 2	2037	103	
North Base Phase 1	2038	90	2038
Bellevue Base Phase 1	2039	71	2040
Bellevue Base Phase 2	2040	71	

Table 2: Base Electrification Schedule

⁹ This is a 20 percent spare ratio, selected by Metro to be higher than the Federal Transit Administration’s recommended 17 percent spare ratio to allow for uncertainty associated with adapting to this new technology. Over time, up to three additional buses could be scheduled for use on routes. FTA requirements for spare ratios can be found at this link: <https://FTA Spare Ratio>

¹⁰ South Annex will also support diesel-hybrid buses and have a fueling station.

MARKET ANALYSIS

The zero-emissions bus market includes trolleys, battery-electric and fuel cell electric buses. The market is rapidly developing. Transit agencies also have access to funding aimed at offsetting the incremental costs between conventionally fueled buses and zero-emissions buses (e.g., the Federal Transit Administration’s Low or No Emission Vehicle Program). As policies are pushing for cleaner technology and more agencies adopt electric buses, technology providers, including bus manufacturers, charging equipment vendors, and software developers, are offering more products that contribute to market growth. At the same time, industry standards are evolving to reduce barriers to cleaner bus technology.

Figure 2 shows the increase in awards and actual deliveries of zero-emissions buses since 2009. The market is also benefiting from the introduction of products from new original equipment manufacturers (“OEMs”). As a result, competition for zero-emissions bus technologies is increasing for better and more affordable technologies.

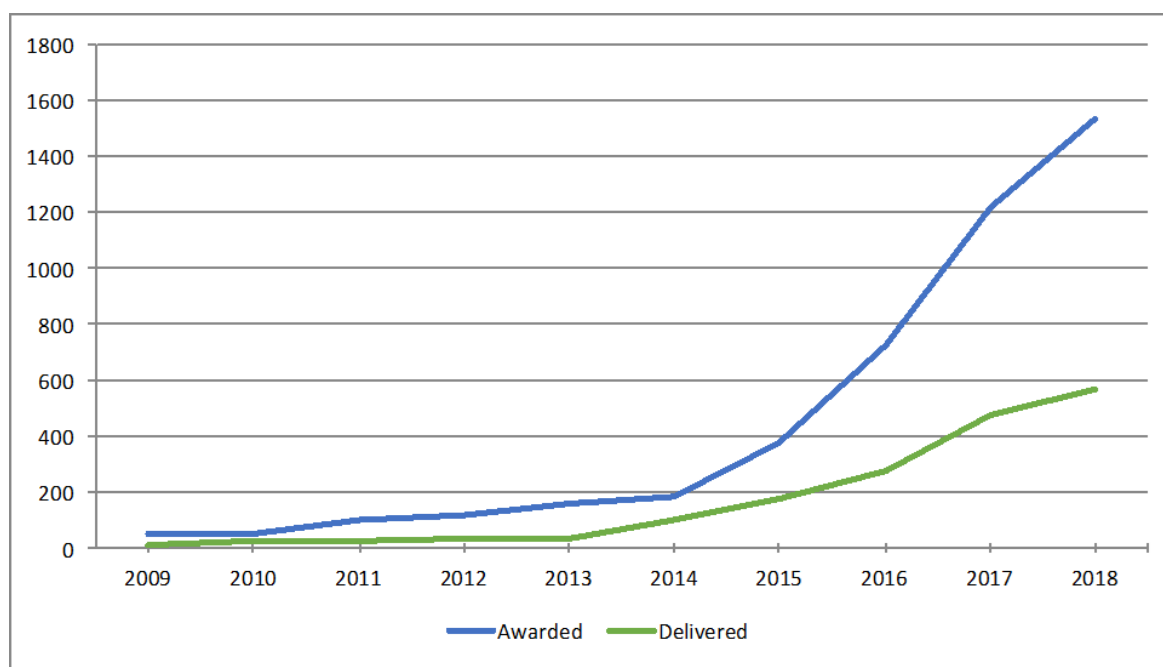

*2018 represents awards and deliveries through August

** Some Low-No award quantities are estimated

Figure 2: Zero-Emissions Bus Cumulative Awards and Deliveries by Year

Table 3 highlights currently available zero-emissions bus body styles by energy storage capacity and OEM. Note that the information in the table may not reflect all currently available bus models in the U.S. market; the information was current as of the published date of this document. The greatest number of vehicle offerings is in 40-ft low floor models, followed by 35-ft vehicle offerings. In order to ensure the buses are eligible for federal funding, OEMs are presenting buses to undergo testing at the Altoona Bus Research and Testing Center. Reports for zero-emissions buses that have successfully completed Altoona testing are available on the testing center’s website: <http://apps.altoonabustest.psu.edu/>

Body Style	Length	Energy Storage (kWh)		OEM									Total		
				BYD	CCW	ENC	GILLIG	GreenPower	MCI	NovaBus	Proterra	New Flyer		Van Hool	
Battery Electric Bus Low Floor	30	210	- 496	2	1			1							4
	35	94	- 440	1	1			1			5	1			9
	40	94	- 660	2	1	1	1	1		1	7	3			17
	45	320	- 323	1				1							2
	60	320	- 818	1								3			4
Battery Electric Bus Coach	23	134	- 134	1											1
	35	348	- 348	1											1
	40	391	- 391	1											1
	45	496	- 496	1					1				1		3
Battery Electric Bus Double Decker	35	170	- 170	1											1
	45	230	- 478	1			1								2
Battery Electric Bus Total				13	3	1	1	5	1	1	12	7	1	45	
Fuel Cell Electric Bus Low Floor	40					1						1			2
	60											1			1
Fuel Cell Electric Bus Total				0	0	1	0	0	0	0	0	2	0	3	
Zero Emission Bus Total				13	3	2	1	5	1	1	12	9	1	48	

Table 3: Available Zero-Emission Bus Styles by Energy Storage Capacity and OEM

As previously referenced in the discussion of **Energy** and **Power**, there are several options for charging battery-electric buses. Options include: plug-in charging (e.g. at a base), conductive charging (at base or on layover), and inductive charging (at base or on layover). Metro has completed an analysis of charging options and the preferred strategy is discussed in more detail further in this document (see Section “Charging Strategy,” page 16).

FLEET AND PROCUREMENT

2019 Zero-Emissions Fleet

Currently, Metro is testing 10 extended range battery-electric buses, manufactured by BYD, New Flyer, and Proterra. As other OEMs develop battery-electric buses, Metro will evaluate them. The first 10 test buses include 40-ft buses and 60-ft articulated buses, two per length (40-ft or 60-ft), and per OEM¹¹. The buses, batteries, and charge facilities are leased. Testing is being conducted to verify the 140-mile range and performance with various loads, terrain, and weather conditions. During the summer and fall, the buses performed at or above expectations. More testing is required to gain additional experience with revenue service and operation in cold weather. Three test buses, the 40-ft Proterra and the 40- and 60-ft New Flyer buses, began revenue service in September 2019 and will operate into 2020. One 40-ft BYD is in testing and the second 40-ft BYD will begin revenue service shortly. The 60-ft BYD buses begin testing and revenue service

¹¹ Proterra does not manufacture 60-ft articulated buses, therefore the test buses consist of two 40-ft BYD buses, two 60-ft BYD buses, two 40-ft New Flyer buses, two 60-ft New Flyer buses and two 40-ft Proterra buses, for a total of 10.

during Q1 2020. The testing will help Metro staff learn more about the technology and complete updates and revisions to training requirements and documentation.

Early Short Range Proterra Fleet

In 2016, Metro purchased three first-generation, rapid-charge, Proterra buses followed by a purchase of eight second-generation Proterra buses in 2018. These buses have a range of approximately 25 miles. Metro evaluated competitive vendor proposals and chose to work with Proterra because, at the time, they had deployed the most electric buses in North America. Currently, these buses are in revenue service for two routes, 226 and 241, supported by both layover¹² charging, at Eastgate Park-and-Ride, and base



Figure 3. Current Gantry Charging Structure at Eastgate Park-and-Ride

charging at the Bellevue Base. Eastgate has three chargers on a single gantry with capacity for five chargers, the first of its kind in North America (see figure 3). These buses provide valuable information regarding electrical usage and utility charges and allow Metro operators, mechanics and riders to experience the technology.

As late as 2018, the electrical dispenser mechanism developed by Proterra, and used by the Eastside routes 226 and 241, known as infrastructure-mounted blade charging (“blade charging”), was being considered as a standard by the Society of Automotive Engineers (SAE)¹³ J-3105 standards committee (see Section “Procurement Strategy and Standards,” page 12) for more information on SAE standards).

However, in the final published standard blade charging was not included. Metro is actively working with Proterra for a retrofit to allow these buses to participate in general revenue service and meet the new SAE standards were adopted in January 2020 and are expected to be incorporated in Metro’s 2020 procurement documents. However, for at minimum a decade, Metro can continue to use the Proterra blade-charging buses in revenue service because the infrastructure exists and there is no need to replace the infrastructure until the electrification of Bellevue Base occurs.

Trolley Buses

Metro has successfully operated a zero-emissions trolley program since 1939. Currently, the trolley fleet comprises approximately 12 percent of the total fleet (174 trolleys). The trolleys run exclusively in Seattle and will continue to be an

¹² Layover charging is sometimes referred to as on route or fast charging.

¹³ SAE International is US based professional associated and standards developing organization for engineering professionals. See <https://www.sae.org>

integral part of Metro's zero-emissions strategy. The trolleys include battery energy storage to allow short distances operation without overhead wire. Metro will continue to explore innovations in the batteries that support trolley. Currently, there is testing being conducted in San Francisco that may result in utilizing larger energy capacity batteries (in the same physical space) that will allow for longer battery-powered off-wire operations, further enhancing the off-wire capabilities of the zero-emissions fleet.

Fleet Planning

The fleet plan—i.e. projections for types and timing of purchase of new vehicles - is regularly evaluated through Metro's Fleet Steering Committee. There are numerous upward pressures affecting fleet purchasing and mix. King County Metro and its key service partners, like the City of Seattle, would like to add additional peak service but are limited by base capacity. Sound Transit, for whom Metro operates buses, has also expressed a desire to increase peak service in the early 2020s. The passage of I-976¹⁴ means fewer options for regional transit authorities' taxing power and ability to collect fees and a need for state, county, and local policymakers to make difficult decisions about funding that impacts service. There is the general threat of recession that could reduce transit tax revenues and push Metro toward cutting service.

Based on the above factors and other relevant information, the Fleet Planning Steering Committee evaluated the number of battery-electric buses to be procured in 2020. It was determined that an equal number of 40-ft and 60-ft battery-electric buses would be procured in time for phase in of battery bus service beginning in the 2021 fall service change. The current order amount is for a total of 120 battery-electric buses for the 2020 procurement.

Procurement Strategy and Standards

SAE International, also known as the Society of Automotive Engineers, is a global association of engineers and technical experts in the aerospace, automotive, and commercial vehicle industries whose core competencies include standards development through consensus. Establishing technical standards are for the purpose of advancing quality, safety, and innovation in these industries. The organization has established more than 37,000 standards in their history. In a rapidly changing field such as electric vehicle technology, standards serve to establish baseline attributes of various systems (such as charging systems) that enable a level of standardization to facilitate commercial adoption while the industry continues to evolve. The SAE standards denoted in this document were agreed to by all North American bus manufacturers, including Proterra, and will be used for procurement documents to ensure consistency and interoperability exists between chargers, charge dispensers and buses. See Appendix D for a detailed summary and status of the SAE standards applicable to the decisions made by Metro.

¹⁴ I-976 is a statewide initiative that passed in November 2019. The initiative limited annual license fees and repealed authorization for certain regional transit authorities to impose motor vehicle excise taxes. Passage has meant certain funding source are uncertain as the County, with other jurisdictions, litigates the legality of I-976.

When the 2017 Metro feasibility study was released, the North America bus charging standards were not finalized. Charging standards were called out in the 2017 study as a key requirement to support the battery-electric bus industry. Currently, there are four proposed standards—plug-in charging (SAE J1772 CCS-1), pantograph down charging (SAE J3105-1), pantograph up charging (SAE J3105-2), and pin and socket (SAE J3105-3). After review and approval through the Zero-Emissions Bus Program governance structure, Metro is recommending purchase of buses using the pantograph down charging standard, SAE J3105-1, for multiple reasons. All North American bus manufacturers have experience building to this standard. It lessens the weight on the bus because the bus carries minimal charging hardware; a lower weight bus allows for greater range and longer battery life. This charging system places all responsibility for charger connection on the technology and not on the operator through the standard’s hardware, communication and geo-positioning mechanism. Additionally, fleet maintenance prefers the pantograph down standard because it lessens bus maintenance.¹⁵ Plug-in charging ports (SAE J1772 CCS-1) will be available for maintenance needs and on road recovery if necessary (Decision memo included at Exhibit A).

There are various types of battery configurations. Certain battery chemistries respond better to slower charging (i.e. the type of charging that occurs at a base – a slow and steady current) or to faster charging (the type of charging expected with layover for quick “top-offs”). Batteries also use different methods of cooling, either air or liquid. The battery chemistry described in the 2020 procurement documents will be optimized for the charging model designed for Interim Base—predominantly slower-power, on-base charging. As Metro deploys layover charging and analyzes service data, the agency may determine a different battery chemistry would optimize service. This could result in the procurement documents needing to be altered. However, Metro will not require a certain battery size or chemistry; rather, the procurement documents will detail performance and maintenance requirements to which the OEMs will respond with a battery design they believe most appropriate. All test buses are meeting operational requirements though further testing is needed in cold weather.

All Metro Bus procurements are regulated by Federal Transit Administration (FTA) requirements. FTA requirements are the result of pertinent sections from the Code of Federal Regulations, the FTA Master Agreement, and the FTA Circulars.¹⁶ Metro has a strong history of successful procurements and will continue to follow the established process when procuring battery-electric buses. The Metro steps to procurement can be found at Exhibit D.

OPERATIONS

There are approximately 20 to 30 routes in South King County that are likely to see some portion of their service profile covered by the first battery-electric buses when

¹⁵ Portland, New York City, Toronto, LA, Edmonton and Vancouver transit agencies are all using this standard.

¹⁶ More detail about FTA requirements can be found at: <https://FTA Procurement>

they go into service in 2021¹⁷ (see Figure 4 for a map of the potential routes and Appendix C for more detail). The service profile design began by analyzing all routes from South Base. From these routes, Metro’s scheduling group identified vehicle assignments of less than 140 miles, a range current testing supports, and the range required in the procurement documents to determine which routes would be supported from Interim Base. In the September 2021 service change, it is expected there will be just over 30 battery-electric buses going out in the morning and evening sign-outs from Interim Base. If the battery-electric buses perform as expected, by the service change in September 2022, the goal is to have 100 battery-electric buses operating from Interim Base

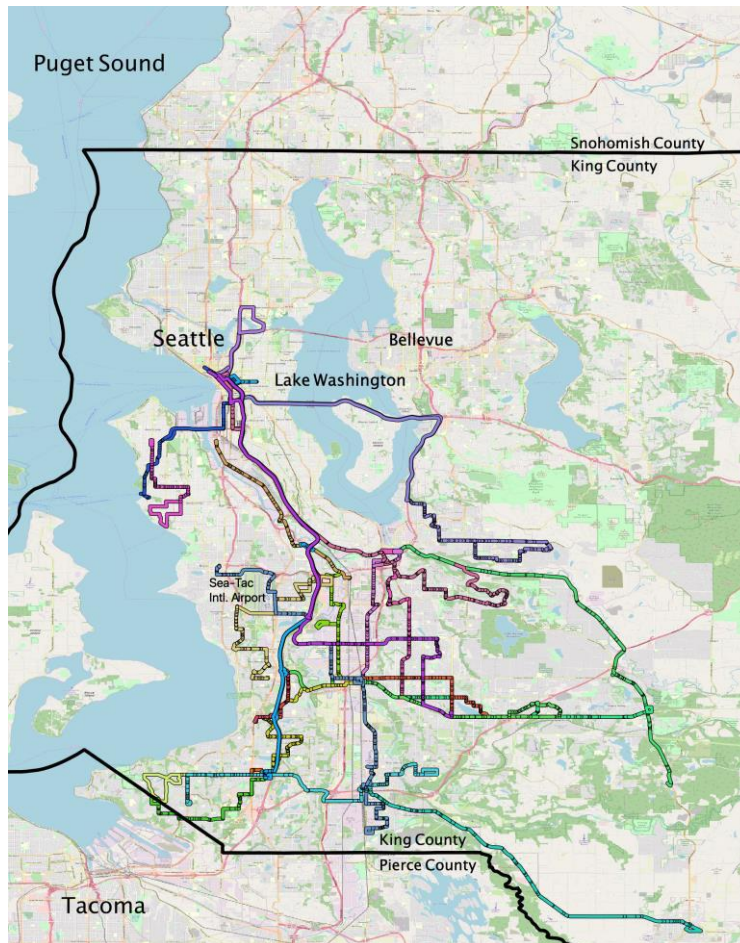

Figure 4. Map showing the potential Interim Base routes

during the morning and evening commutes. The service profile has been designed to mitigate risk and ensure operational success. Since service growth does not require these buses to operate on weekends, Metro will include weekend service after a sustained period of success. To further mitigate operational risk, the buses will operate during morning and evening peaks, allowing required mid-day and overnight charging.

Once South Annex Base is built in 2025, in combination with layover charging for service out of South Annex, battery-electric buses can be assigned to vehicle assignments that are longer than 140 miles. To support this, Metro needs to analyze range requirements and what, if any, layover charging is necessary to support regular service and to potentially reduce the size of the battery on the buses. As park-and-rides and other Metro assets are developed into mobility hubs or transit-oriented development, there may be opportunities to prepare for future, layover electrification today. An initial set of technical requirements for electric service needs to be developed, and these electrical design requirements can be

¹⁷ The 120-bus procurement of battery-electric buses will begin with 40 to support the initial opening of Interim Base. Eventually, there will be 100 battery-electric buses in service and 20 battery-electric buses in reserve

included in the larger design and layout as these redevelopments occur. By appropriately sizing the electrical infrastructure to support layover, Metro will be able to deploy layover charging at later dates with minimal additional costs (see Section “Charging Strategy,” page 16).

To ensure that battery-electric bus implementation timelines are met, service preparation needs to be appropriately planned and resourced. Prioritizing electric bus preparation may be required to meet battery-electric bus implementation timelines.

FACILITIES

Interim Base will open in two phases. The first phase, currently under construction, will open in September 2020 with 40 40-ft hybrid-diesels. By fall of 2021, the second phase of Interim Base will open with electrification to support a phased roll in of 120 battery-electric buses over the course of the next year. Currently, there is a conceptual design for an electrified Interim Base. The buses will be parked end-to-end with overhead gantry, pantograph down charging. There will be 100 dispensers/pantographs and 35-50 chargers, allowing 35-50 buses to charge at the same time at various preset power levels. Interim Base will include approximately a 1:12 of higher-power to lower-power chargers. If Interim Base is decommissioned, some components of the electrical and charger infrastructure could be reused at permanent bases (for example Ryerson or Bellevue) (see Appendix B for layout drawing¹⁸). Additionally, Metro is planning on building up to 10 chargers at the existing South Base. Known as the South Base test facility, this location will support Interim Base and South Annex Base. It is anticipated this facility will be used for vehicle preparation, maintenance, commissioning, testing for new technologies, scheduled on-base charger upgrades and as redundant chargers if on-base chargers fail at Interim Base.

South Annex Base is scheduled to open in 2025 with the ability to support up to 250 battery-electric buses. Currently, the South Annex Base is in the planning phase and is expected to enter permitting in Q1 2022. Construction is scheduled to begin in July 2022 and be completed in May 2025, with opening scheduled for September 2025. A summarized timeline can be found in Table 4. See Appendix E for the proposed detailed timeline.

TASK NAME	START	FINISH
South Annex (SA) – Permanent Base	06/2018	09/2025
Planning	06/2018	05/2019
Design	06/2019	04/2022
Relocation	11/2018	09/2020
Demolition	09/2020	09/2021
Construction	01/2022	05/2025
Commissioning and Turnover	05/2025	09/2025

Table 4: South Annex Base Construction Summary Timeline

¹⁸ The conceptual design can be located in the South Base Battery Electric Bus Interim Facility – Conceptual Design report that was prepared for Metro by Parametrix. Copies available upon request.

There are challenges around the timelines between construction of new bases and battery-electric bus deployment. As existing bases are updated, service must continue at its usual rate. However, base capacity may become more constrained due to base construction resulting in buses having to be moved between bases. The timelines around battery-electric bus arrivals and base space will require engaged management and route/coach movement from service change to service change.

A commissioning and hand-off plan is being developed for the charging infrastructure. Among other things, this plan shall include: installation diagrams, manuals and other documentation, training for maintenance personnel, mean time between failures rates for components and associated recommended critical spares list. Before charging manufacturers will sign-off on installation and issue warranties, the manufacturers will likely require a certain amount of successful connections and charges between the buses. The management and timeline of this commissioning needs to be determined by Metro Transit Facilities Division, Capital and the charging manufacturers. Additionally, Metro will manage these new assets through its existing Enterprise Asset Management (EAM) system, which includes warranty management and parts management i.e. what parts are long lead time and need to be stored on site (see Section "Asset Management," page 23). Metro is applying the lessons learned at the Eastgate Park-and-Ride and Bellevue Base to develop this program, as well as partnering with suppliers and other transit agencies.

CHARGING STRATEGY

Since the 2017 study, the battery-electric bus program has evolved, and Metro's focus has moved to lower-power, on-base chargers. These chargers can supply a range of up to approximately 140 miles, which is about 70 percent of vehicle assignments. Interim Base is designed with a majority of lower-power chargers (see Section "Facilities," page 15). Slower charging can better maintain battery life (fast charging may degrade batteries more quickly) and lower utility demand charges due to lower power use. The downside of slower charging is that it requires longer charge times and may result in buses not being ready for service. To mitigate this risk, four (4) fast chargers – capable of charging Metro's chosen battery in about one (1) hour – will be built on Interim Base (see Section "Facilities," page 15). Fast chargers will not be used by all battery-electric buses, but will be available for a battery-electric buses with low states of charges at midday or those that need to return to service quickly. South Annex Base will likely have some combination of slower and faster on-base charging (see Appendix A for description of charging of electric vehicles) and likely will be augmented by layover charging. On-base charge management is also an important consideration to reduce overall electrical costs while ensuring bus availability. A preliminary analysis of different charging methods on sample blocks is shown in Appendix F. This analysis demonstrates the effect of different charging schemes on electrical demand, energy and cost.

As the program is evolving, it seems clear that there will also be a need for layover charging for more frequent routes, like Rapid Ride bus rapid transit service. An open question is when and where Metro should deploy layover charging. Layover charging will require significant electrical infrastructure in multiple jurisdictions

throughout the County. Additionally, it likely requires partnering with other transit agencies (Sound Transit) who also own key terminal locations in King County. Route selection for South Annex is being examined to determine how much and where to locate layover charging. The data from the first 120 battery-electric buses deployed from Interim Base will be helpful in determining the amount of layover charging necessary for routes running from South Annex. An important benefit of layover charging is it provides for additional resiliency because it distributes the charging network over a larger area, preserving some service capabilities in case of a localized outage. It also provides an opportunity for smaller battery packs on the buses.

Deploying a successful layover charging program will require Metro to appropriately budget for infrastructure requirements. Driven by the South Annex service profile, a strategic analysis of Metro-owned and other governmental-owned properties is being conducted for potential locations to deploy layover charging. Conversations with local jurisdictions in regard to land-use and permitting should begin once a comprehensive layover charging strategy is developed.

Charging Infrastructure Deployment

Charging infrastructure is comprised of an electrical connection component (plug/socket), communications (antenna), IT (software) and a structural component. For Metro’s preferred charging method, the structural component is a concrete base, steel truss gantry that holds the charging heads and the connection to the bus. As previously discussed in “Procurement Strategy and Standards”, Metro has chosen to use a pantograph down system (see Figure 5). Attached to the pantograph, through electrical wiring, are contact bars that dispense the electricity. There are various manufacturers building charge heads.¹⁹ Depending on the charger manufacturer chosen, the footprint required for the cabinets and switchgear will vary (see Appendix G for pictures of gantry and switchgear/cabinet and technical details). A diagram of the typical equipment necessary to support DC charging is included as Figure 6.



Figure 5. Overhead charger with an inverted pantograph (moving parts on charger, not on the bus)

¹⁹ Some of these manufacturers include Siemens, ABB and Heliox.

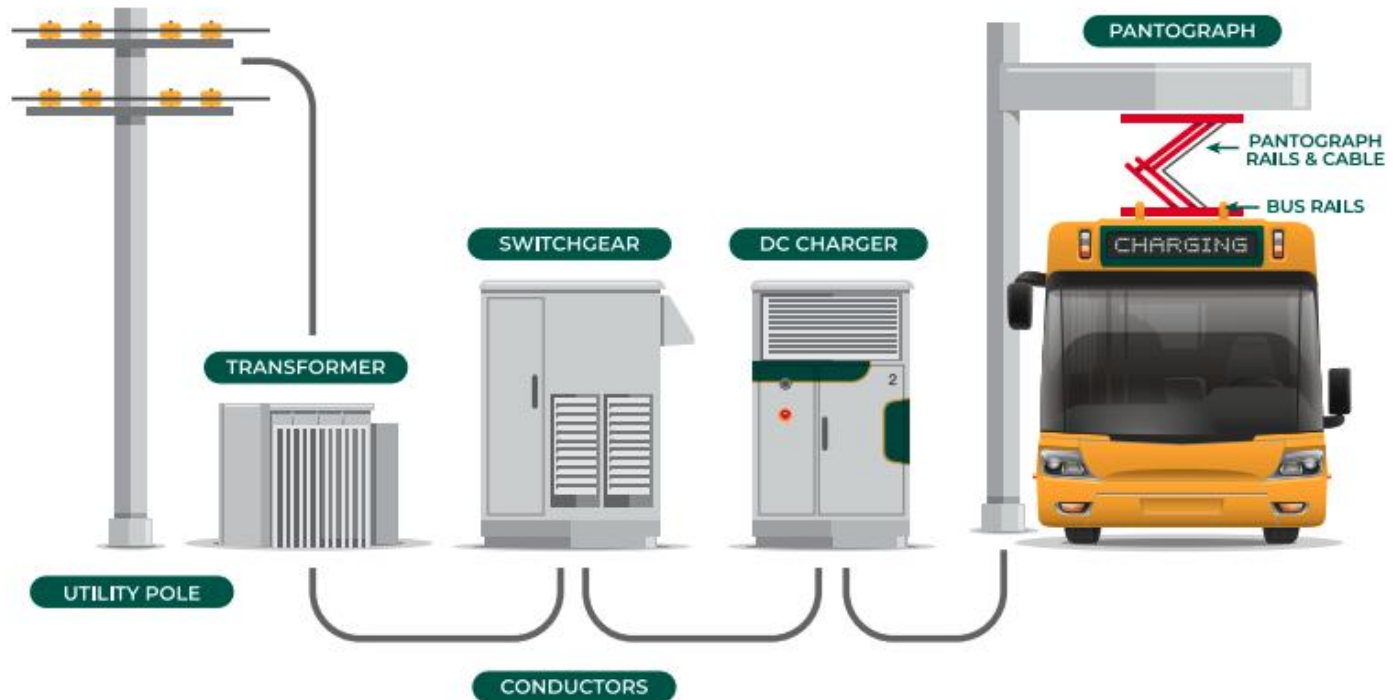

Figure 6. High-level charging infrastructure schematic

To further reduce the electrical infrastructure footprint, Metro is working with the utilities to bring DC as a service²⁰ to the bases. A presentation explaining DC as a service prepared by the Electric Power Research Institute (EPRI) is included in Appendix H. If the utility can make this service available, it requires an on base substation with switchgear contained within the substation but fewer electrical cabinets, therefore reducing the overall electrical infrastructure footprint and costs. The gantry, pantograph system and charging equipment would be unchanged.

Metro built and operates three (3) bus chargers at the Eastgate Park-and-Ride and one (1) at Bellevue Base all capable of high-power, fast charging. An additional low power plug-in type maintenance charger is installed at Bellevue Base. The chargers are used to charge the original 11 Proterra buses (see Fleet). For the remaining leased test buses, the manufacturers have leased charging facilities. Metro is determining the best approach to obtaining charging infrastructure. The multiple options include:

1. Continuing a lease model;

²⁰ Historically, AC has been the preferred method of power delivery to businesses and residences because it is more efficient for long distance travel. With the advent of server farms, which require DC power, the utilities are looking into providing DC as service. For more information about the future of DC as a service see Appendix H.

2. Metro building and owning the charging infrastructure;
3. Working with local utilities to build the charging infrastructure while Metro owns it;
4. Working with bus manufacturers on building the charging infrastructure while Metro owns it;
5. Or some variation of the above.²¹

Currently, Metro is working with Seattle City Light to explore a process where Metro is the lead agency with an inter-local agreement for Seattle City Light to build the charging infrastructure. In August 2019, Metro and Seattle City Light signed a Letter of Intent to explore this partnership and will work towards formalizing this relationship during Q1 2020.

Utility Rates

As Metro moves forward with the battery-electric bus program, one of the keys for success is negotiating an appropriate tariff with the utilities. Metro buses operate in both Seattle City Light and Puget Sound Energy territory. Interim Base and South Annex Base are in Seattle City Light territory. Metro is actively engaging with both utilities on tariff rates, but is initially focused on Seattle City Light because of the nearer term projects. Figure 7 shows the service areas of Seattle City Light and Puget Sound Energy.

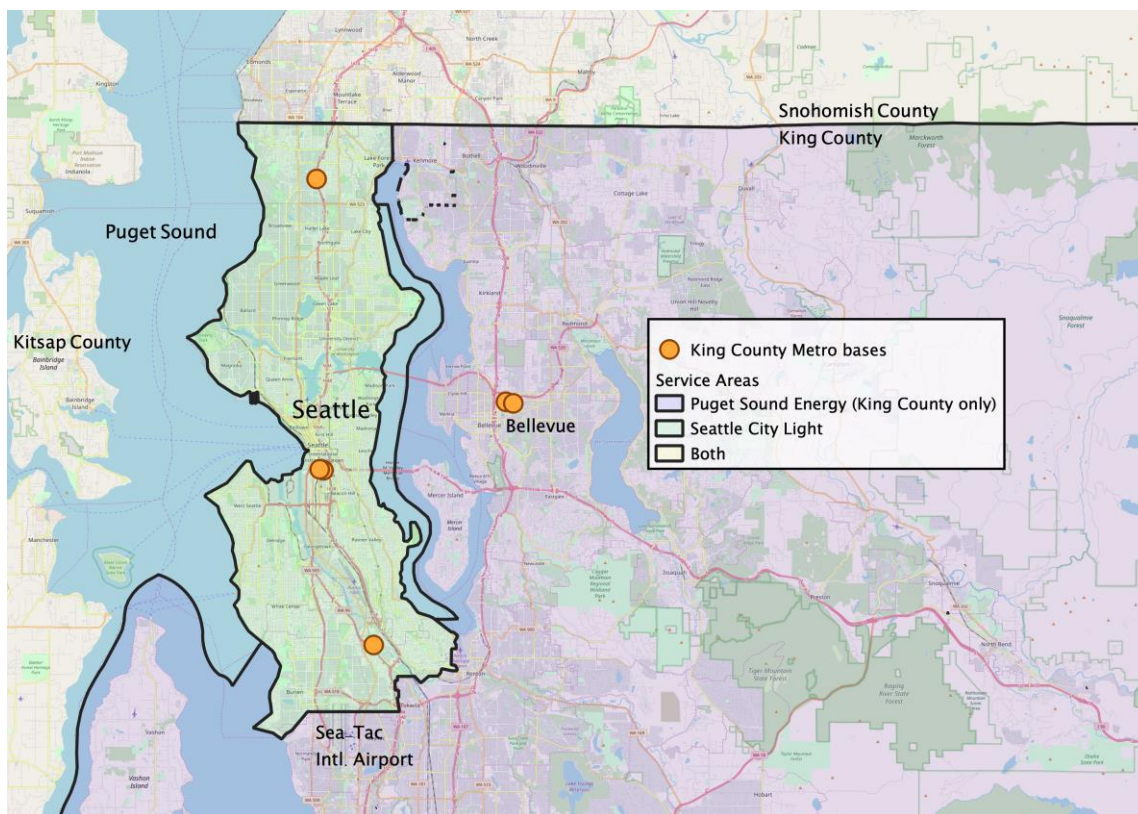

Figure 7. Service areas of Puget Sound Energy and Seattle City Light

²¹ Other transit agencies including LA, Portland and NY, have used or are exploring having utilities build charging infrastructure

In general terms, monthly electricity bills resulting from vehicle charging typically have the primary components described in Figure 8. First, there is a **fixed** or minimum cost that is applied per meter regardless of the amount of electricity actually used. Second, there is the actual cost of **energy** (commonly called “usage”) which is calculated by applying a rate per kWh to the total kWh’s used by the chargers to replenish the batteries in a given month. Third, utilities typically assess a **demand** charge, which is applied per kW based on the maximum power drawn by the chargers (also commonly called “load” or “demand”) within a given time period each month. Depending on the type of tariff structure, different energy and/or demand rates may apply based on time of day (peak versus off-peak periods). Furthermore, these peak periods may change based on season of the year. Finally, **taxes and fees** are assessed. There can be a number of individual fees, some of which are based on usage and others based on demand.

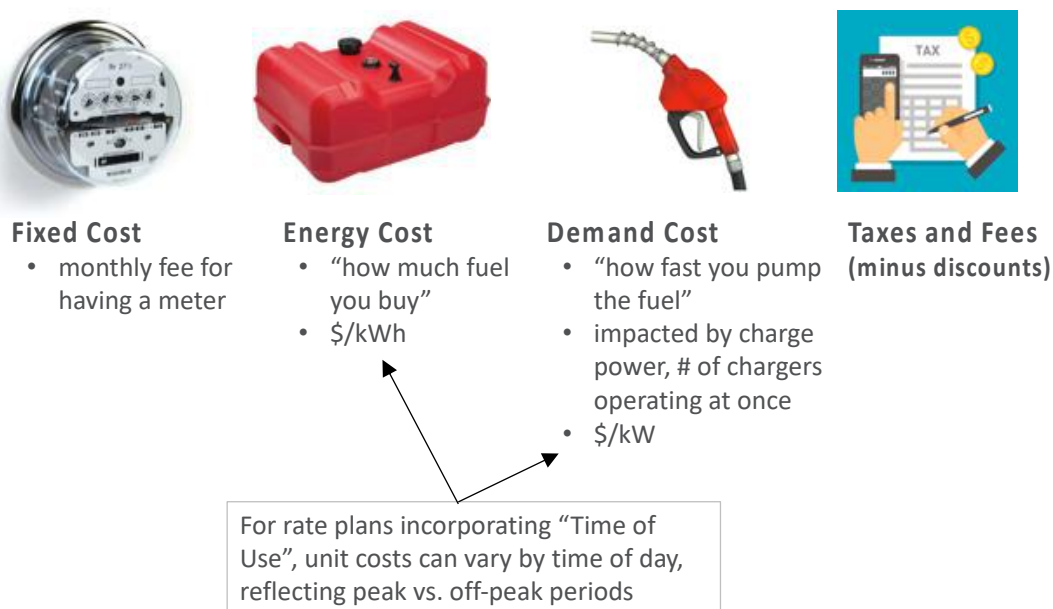

Figure 8. Typical Utility Bill Components

Other utilities have provided pilot programs for transit electrification. Southern California Edison offers a rate that eliminates demand charges for five years and recovers all costs through fees based on the amount of energy consumed. The rate gradually reincorporates demand charges at a lower level over the following five years. Pacific Gas & Electric has a subscription fee in 10 kilowatt (kW) or 50 kW increments, dependent on the maximum anticipated demand. Pacific Gas & Electric has time-of-use charges that are the same across all seasons—a model that Seattle City Light already uses. Hawaiian Electric Companies is administering an E-BUS pilot tariff establishing time-of-use rates incentivizing charging during mid-day hours, when there is abundant solar energy, and during overnight hours when demand is otherwise low. Hawaiian Electric Companies has on-demand charges during on-peak timeframes.

Currently, Metro’s South Base is under the City of Tukwila, Medium General Service tariff.²² Seattle City Council adopted a rate pilot ordinance providing Seattle City Light the authority to offer three-year pilot programs to support transit electrification²³. Over the next months, Seattle City Light and Metro will be working together to model hourly usage and potential rate structures. The pilot transit tariff should, while not burdening rate payers, acknowledge the benefits that electrified transit provides the community. The agreed upon rate structures are needed by early 2021 and should be in place in time for service in mid-2021, a few months ahead of the opening of Interim Base. For South Annex Base, the pilot will likely be adjusted and/or become a formal tariff. Seattle City Light will have to take a formal tariff through its regulatory process and receive Seattle City Council approval. The current intent is that these tariffs will apply to charging for battery-electric buses that Metro owns and operates, and not to other Metro fleets.

Utility Readiness

Seattle City Light has conducted a system impact study for Interim Base. Seattle City Light has two electrical feeders that are accessible for service. Feeder A runs north/south on the west side of E Marginal Way S and Feeder B runs north/south on the east side of E Marginal Way S. Feeder A can handle the additional load required for Interim Base without any required system modifications. Feeder B is not a viable feeder to support Interim Base. Seattle City Light can support the needs of Interim Base with no significant infrastructure work to the feeders. However, Metro is working with the utility on the best redundancy and resiliency plan. Additionally, Metro will continue to have diesel-hybrid buses running out of the South Base, which can be used if electrical charging fails or if power outages occur that impact to the ability to provide service.

Power Resiliency

A battery-electric bus operating plan must allow for service delivery when there are power outages that last beyond the battery storage capacity. For Interim Base, if there is a power failure, diesel-hybrids will replace battery-electric buses until power is restored. In the longer term, Metro must engage thought leaders and emergency management expertise in designing power resiliency for this new operating model. Resiliency options should extend beyond the local power utility, including on-base solar power, multiples substations or large battery storage banks of reserve energy.

Another challenge is the resilience required for an extended time, such as natural or manmade disasters that extend power outages for a prolonged period as the local power utility is trying to recover their systems. Public transportation is typically a critical infrastructure in the times of natural disasters, not only for regular or amended service, but also as warming coaches, evacuation and relocation, triage and emergency transport. A discussion has begun with Seattle City Light about power restoration to Metro in cases of catastrophic failure. Over the upcoming months, conversations need to occur with local and county emergency managers to

²² <https://www.seattle.gov/light/rates/summary.asp>;

²³

[https://seattle.legistar.com/ViewReport.ashx?M=R&N=Master&GID=393&ID=4129510&GUID=D2884E6E-C4FF-4E2F-A719-1251E82E4B77&Extra=WithText&Title=Legislation+Details+\(With+Text\)](https://seattle.legistar.com/ViewReport.ashx?M=R&N=Master&GID=393&ID=4129510&GUID=D2884E6E-C4FF-4E2F-A719-1251E82E4B77&Extra=WithText&Title=Legislation+Details+(With+Text))

discuss how a potentially electric fleet may change their expectations for major incidents and disaster support to improve recovery services.

IT

Vehicle Data

Currently, Metro collects vehicle performance, mileage, and fault code data for its buses through a Vehicle Information Box (“VIB”). This data interfaces with the M5 maintenance database (“M5”), updating mileage information and identifying potential repair codes and maintenance needs.

As battery-electric buses are launched, vehicle performance, mileage and fault code data will interface with M5 through data loggers that will also provide data elements that are specific to battery-electric bus vehicles, such as State of Charge (“SoC”) and evaluation of battery usage. Under the terms of the procurement documents, any data from the buses will belong to King County and will be provided to the County in an unencrypted “raw” format. Per normal Metro processes, this data will be used to support vehicle maintenance. In the future, the vehicle data should be incorporated into the broader IT platform described below.

Metro is including in its procurement a requirement for Open Charge Point Protocol (OCPP). OCPP is a non-proprietary application protocol that provides communications between the chargers and central management system. OCPP allows Metro to purchase equipment from multiple OCPP compliant vendors without being tied to one supplier. Additionally, Metro is actively looking into Open Automated Demand Response (OpenADR). OpenADR provides for interoperability of information exchange to facilitate demand response benefitting Metro and the utilities by allowing for more precise energy management.

IT Platform

A charge management system is a software/firmware/hardware system that provides control mechanisms over the amount of power being deployed by the charge heads. In theory, this system can prevent unnecessary fees by the utilities, and efficiently manage power to batteries while communicating with the utility to avoid peak demand or grid instability. At its most basic, a charge management system can be deployed at the charger level; the charger is prevented from providing above a preset amount of power, thus preventing multiple chargers from charging at high levels and triggering demand fees. The technology for this type of charge management exists and is expected to be deployed at Interim Base.

Moving forward, a more sophisticated charge management system will be required to ensure quality operations. In this version of charge management, a backend cloud service integrates with the utility and, based on signals from the utility, charging is decreased or increased. Additionally, these systems can reduce or increase power to specific chargers based on the needs of the attached bus, helping maximize battery life while ensuring buses are charged sufficiently to support service. These systems also provide alerts when charging infrastructure is not working. This type of charge management software exists in the electric vehicle space but is not as robust in the bus space.

Eventually, the charge management software would develop into a comprehensive battery-electric bus IT platform. In this model, the charge management system interacts with the vehicle data software, asset management system and dispatch software. The software should tell the vehicle dispatchers what vehicle assignment a bus is being charged for. Also, it should provide triggers to asset management about vehicle warranties and lifecycle planning while reminding of maintenance intervals or urgent maintenance needs. This requires integration with the enterprise asset management system. Currently, this type of software does not exist but Metro is engaged with various agencies and partners to develop requirements and drive creation of this type of software. It is expected that as electrification of transit matures, more of these solutions will enter the market and be available.

ASSET MANAGEMENT

The battery-electric bus program will create new assets and require retrofitting of existing assets. The Asset Management program manages the life cycle of assets by tracking, assessing, monitoring and planning to ensure assets are at State-of-Good Repair and Metro practices align with Metro's three strategic objectives including safety, sustainability, and equity and social justice. Asset Management begins with capital planning, procurement, project design and construction when new asset information is registered in Metro's EAM system. Assets conditions are assessed during the operational and maintenance cycle.

Assets associated with the battery-electric bus program include fixed assets, like bus bases and charging equipment, fleet and information technology. Warranties, spares, safety instructions, user manuals and other items associated with assets must be tracked and monitored while Metro acquires, builds and retrofits assets. Any assets in partnership with other agencies, such as Seattle City Light and Puget Sound Energy, will be managed and assessed through Metro's Asset Management system. The assets, which no longer meet the business requirements, shall be disposed of, repurposed or recycled.

WORKFORCE

By 2021, a training and educational program for vehicle maintenance, operators and other employees working with battery-electric buses should be in place. Though bus operations at Interim Base should not change, training is required for battery maintenance, electrical infrastructure maintenance, bus cleaning and maintenance, safety and dispatching, operator training, transit control center and service quality. The development of this program has begun and being led by Metro's Safety and Security department working closely with the Zero-Emissions Bus Program Manager, Vehicle Maintenance Fleet Engineering, Capital Planning, Power and Facilities. In the upcoming months, this group will need to engage with bus manufacturing representatives and the utility and charge dispenser manufacturers to develop a comprehensive training package. Metro may consider hiring a consultant to coordinate and help write the training manuals to meet Metro requirements.

Additionally, there will be task changes for base employees that need to be identified and discussed with various groups. Managers and certain employees

should be hired for Interim Base by Q3 2020, allowing these key positions to be fully engaged in the final construction and operationalization of Interim Base. Longer term, Metro leadership needs to work closely with its operational workforce to assure a successful transition from launch to long-term operations. Metro should also be actively working with local colleges for a pipeline of required trades and competencies as electricians are going to be in high demand as transportation continues to electrify.

EQUITY AND SOCIAL JUSTICE

Long range battery-electric bus service will be launched in South King County where historically underserved communities live. Battery-electric buses benefit communities living in the areas of the bases by reducing ambient noise and eliminating local pollution. Metro may also choose to sponsor educational events/outreach to the community about the new technology and its role in reducing carbon emissions and improving air quality.

In addition, the location of the bases in proximity to areas with a high percentage of priority populations (people of color, low-income individuals, and people with limited English proficiency) will make it easier for Metro partnerships for recruiting and job skills development with local community colleges to reach priority populations. Many of the projects that will be undertaken to implement battery-electric buses will be subject to King County “priority hire” requirements, mandating that contractors advertise and prioritize hiring within zip codes that have lower income and employment levels than the King County Average. In addition, in procurement for projects associated with the battery-electric bus program, Metro will use the “Equity and Social Justice innovation plan,” criteria, offering consultants the opportunity to propose equitable innovations aligned with the county’s Equity and Social Justice Strategic Plan as part of their delivery of projects.²⁴

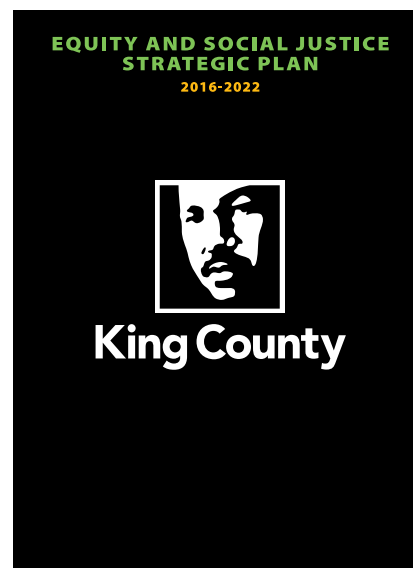

Metro’s internal job training, education, and recruitment programs can also be designed to equitably advertise and offer opportunities to priority populations within the Metro workforce, with the goal that lower-income employees and employees of color will be at least proportionately represented among those who receive training and educational opportunities in emerging disciplines connected to electrification.

There will be benefits to the operator and maintenance workforce, beyond the potential for advancement opportunities through job skills training. Compared to existing technology, driving a battery-electric bus reduces fatigue because of reduced noise, vibration and there is less exposure to the operator and

²⁴ “Priority hire” and “Equity and Social Justice innovation plan” are applicable to all Metro capital programs

maintenance staff to criteria air pollutants²⁵ and toxins (see Exhibit E for a Form of Green Building Ordinance).

COMMUNITY OUTREACH

In conjunction with the South Campus and South King County base expansions, targeted outreach to South King County began in 2019. This engagement was not specific to battery-electric buses but emphasized that the South Campus will house emission-free, battery-electric buses. Metro has a communications plan dedicated to the large-scale launch of battery-electric buses that will roll out in 2020. The plan includes an updated website, video of the technology and various plans to demonstrate the bus throughout the County (see Exhibit F for Communication Plan). Metro also hosts various transit agencies and private companies from the US and Canada who are interested in electrification. Staff are active participants in panels and conferences to share information, learn from other early adopters, and drive technological adoption and development. This information sharing helps avoid mistakes others have made and helps develop solutions to common problems.

Messaging for Metro’s Transition to Battery-Electric Bus Fleet

King County Metro is leading the industry by being an early adopter of a battery-electric bus fleet. Electric buses produce no exhaust, are quieter, and can lower operating costs. Metro has committed to moving to a 100% battery-electric fleet powered by renewable energy by 2040. That commitment helps King County in the plan to combat the climate crisis by reducing the regional greenhouse gas emissions that come from transportation.

Taking action that makes change will protect our climate, air quality, and health of our communities while providing high-quality, efficient public transportation.

That means new battery-electric buses operating from south King County, improving air quality first in communities where people are disproportionately affected by pollution. It also means retrofitting existing bases and building new bases that house and maintain battery-electric buses, starting with Interim Base in 2021, South Annex in 2025, and South King County Base in 2030.

*Communications Plan
Metro’s Transition to Battery-Electric Bus Fleet*

BEYOND 2025, ELECTRIFYING THE BUS BASES

By 2040, Metro’s fleet of more than 2,200²⁶ buses will be fully electrified—a combination of battery-electric buses and trolley buses. To reach this goal, Metro has laid out a phased approach to electrifying the transit system. It is expected that when the new 9th base opens in South King County it will be fully electrified. The current plan is for Central Base to be electrified by 2031, the South Base by 2033, East Base by 2035, Ryerson Base by 2037, North Base by 2038 and Bellevue Base by 2040. Finally, Metro is developing a strategy to fully electrify all other greenhouse gas emitting vehicles in its fleets. Once the strategy is completed, this

²⁵ <https://www.epa.gov/criteria-air-pollutants>

²⁶ This is the forecasted number of buses

electrification effort, in addition to the trolley fleet and streetcar operations, will be integrated with the bus electrification strategy to ensure consistent utility infrastructure and pricing models for Metro. Funding for electrification of battery-electric buses needs to be secured.

With the expansion of Metro's electrified fleet, there will be an increasing need to ensure the continued safe and proper handling of the bus batteries once they have reached the end of their service life. Since this usually happens once or twice before the vehicle frame itself reaches end-of-life, there is a need for a process to handle battery packs separate from their on-vehicle housings. Such a process is already in place for the high voltage batteries coming from Metro's fleet of hybrid buses, with some batteries being recycled and others being reused based upon battery chemistry, market conditions, and safety requirements. However, there are indications that disposal of batteries and fire protection storage costs will increase in the upcoming years. To improve this system and accommodate additional battery quantities, chemistries and configurations, Metro is working with partners, such as the Pacific Northwest National Laboratory and the NAATBatt trade association. Metro is also exploring various other strategies such as OEMs take-back and in-house stationary power applications.²⁷

There will be increasing opportunities to partner with utilities around demand response to further lower electrical bills. IT will continue to evolve with the final goal of a fully-integrated system that both manages electrical load between Metro and the utility but also interfaces with vehicle maintenance, asset management and dispatch software.

Battery-electric bus technology is dynamic; the solutions Metro develops today are expected to be scalable but Metro anticipates there will be changes as the technology matures and Metro better understands how to deploy and manage zero-emissions buses. Metro needs to continually evolve its battery-electric bus program to ensure it is scalable, innovative and sustainable while still providing service at the highest levels and improving on current practices. The next two decades will be a time of tremendous change and growth for both for Metro and battery-electric technology. Enhancements in energy and power density will improve Metro's operational capability and resiliency. The successful opening of Interim Base and South Annex Base, and the new battery-electric bus fleets launched from these buses will set Metro on a great path for future success in reaching a 100 percent zero-emissions fleet by 2040.

²⁷ The U.S. Department of Energy is actively working on lithium ion battery recycling. More information can be found at <https://recellcenter.org/>

EXHIBITS

EXHIBIT A: Work Group Decision Documentation

07/18/2019



Capital Planning | Zero-Emissions Fleet

MEMO

Technology selection for charging Battery Electric Buses

July 18, 2019

Background:

Metro's Capital Division is planning the work required to electrify the Interim Base at South Base Campus. That location is scheduled for diesel-hybrid operations in 2020 and battery electric operations in 2021. Consulting firms Parametrix and Heliox have been engaged to provide technical support to the Planning and Design phases using the latter's experience with designing large electric bus bases in Europe in as short as 18 months. The outcomes from the consulting work are not expected until later in August/September and to not delay planning and design activities, Metro decided to proceed as described in this MEMO.

Challenge:

One of the significant decisions is to determine which charging method is best suited for Interim in the context of two parallel needs. The first need is for Interim to be a blueprint that informs future designs at bases that will operate twice the number of buses. The second need is to select a solution that allows Metro to stay on the fast track for design and construction, for charging availability in September 2021.

Solution:

Battery Electric Buses can currently charge using three methods:

1. Automated Overhead Conductive (defined in the SAE J3105 document)
2. Plug-In, similar to cars (defined in SAE J1772 CCS document)
3. Inductive, wireless power transfer (defined in SAE J2954 document)

The third option was eliminated from the decision making process due to the technical and safety challenges that have not been resolved to the satisfaction of the heavy duty transit bus industry. The driving factor is the low power levels, making this an impractical solution for most charging location opportunities coupled with the lack of interest from the majority of bus builders.

The second option was evaluated and the North American version known as SAE J1772 CCS Type 1 was placed under consideration for lower power charging at a base either for charging multiple buses or potentially only for maintenance use in low quantities.

07/18/2019

The first option has three derivatives known as Pantograph Down (3105-1), Pantograph Up (3105-2) and Pin & Socket (3105-3). These configurations allow for the higher power levels needed for overnight or mid-day base charging as well as future en-route charging opportunities similar to the ones deployed at Eastgate Park & Ride.

Recommendation:

After significant research, the Capital Planning Facilities & State of Good Repair group summarized the available options in a Memo dated July 10, 2019 backed up by a chart that illustrated features and risks.

The Program Coordination Team (PCT) of the Zero-Emissions Fleet, Bus Electrification Program convened on July 16th to discuss and determine if a selection can be made or if the Program Sponsor, Diane Carlson would be requested to convene the Program Oversight Group for a decision regarding which solution to pursue. The PCT achieved consensus that the following two standards will be pursued, to purchase buses and to build charging infrastructure, unless other significant information surfaces that would require the organization to pivot away from this decision.

For **Base and for En-route charging**, **SAE J3105-1** was selected based on the following merits:

- The only one of the three solutions that has been deployed in North America with current operations in Vancouver, Montreal, NYC, Portland and is in process of being deployed in LA, Chicago and Toronto
- Its automated operation is similar yet simpler than that at Eastgate (that solution is not going to be part of the standard J3105)

For **Maintenance Support activities**, **SAE J1772 CCS Type 1** was selected based on the following merits:

- It is widely used and deployed in North America as the High Power DC Fast Charger for personal cars (exclusive of Tesla), as opposed to the Type 2 which was selected in Europe
- It is currently the solution being tested at Metro on the longer range buses and has worked on the shorter range buses for a few years as well

Respectfully submitted,



Danny Iliou
Zero-Emissions Fleet
Program Manager



Fleet Planning Steering Committee

Bill Bryant
Service Development
Section Manager

Chris Parrott
Vehicle Maintenance
Division Director

Tim Flanagan
Bus Operations
Division Director

Jonathon Bez
Chair, Fleet Planning
Steering Committee

Bill Thon
Fleet Procurement
Superintendent (acting)

Tina Rogers
Capital Planning
Section Manager

Jill Krecklow
Finance and Administration
Finance Manager

Greg Svidenko
Finance and Administration
Capital Budget Coordinator

Grantley Martelly
Safety and Security
Section Manager

Fleet Planning Working Committee

Danny Illou
Capital, Zero Emission Fleet

Lisa Shafer
Capital, Base Planning

Dale Hartman
Facilities, Program Manager

Dan Santon
VM, Functional Analyst

Don Goodwin
VM, CSC Superintendent

Carle Lee
Sustainability Coordinator

Dion Graham
ADA System Administrator

Katie Chalmers
Service Planning Supervisor

Dave VanderZee
Service Planning

Fleet Planning Steering Committee

July 30, 2019, 2pm to 3pm
King Street Center, Directors Conference Room (8279)

NOTES – Decisions are **BOLDED & ALL CAPS**. Follow up items are underlined.

1. Current Fleet Procurement Update

a. 40' Gillig Hybrid (7300, 195 coaches)

Metro has taken delivery and accepted 100% of this fleet. As of July 30th, 102 of 195 coaches were in service, with the rest still waiting on service prep.

b. 60' "RapidRide Ready" (6300, 28 coaches)

24 of 28 were delivered. None are in service yet, but a number of the coaches have now been wrapped for service in Metro's standard colors.

2. Upcoming Fleet Procurements Update

a. 60' "RapidRide Ready" (6300/8300, 60 coaches in 2021)

Metro's RFP for this order is now targeted for October this year.

b. 60' 5 Door RapidRide (AKA "Madison BRT, G Line", 13 Coaches)

This procurement continues to track as a unique 5 door (2 streetside doors) hybrid bus procurement needed in 2022. New Flyer is the identified builder.

3. Subcommittee Report - Putting Leased Coaches into Rev. Service

The work group continues to work toward prepping 5 leased battery buses for revenue service to start in August/September timeframe. The group briefly discussed the approach of the customer feedback associated with this effort. Customer feedback would focus on look, sound, and touch aspects of the bus. We might also schedule a special event that could provide a good backdrop for County leaders to discuss Metro's commitment to 100% ZEVs by 2040. That would also provide an opportunity for Metro to ask customers to compare and contrast the various aspects of the coaches that they like or dislike.

The Safety asked to more fully participate in this effort so that Metro would be well positioned on the training and hazard prep front. Safety had some concerns about the interior battery storage and whether the coaches allowed for proper line of sight for the Operator to monitor the entire coach.

The Committee heard a report out from Lisa Shafer on what has been discussed and recommended thus far in the weekly meeting series to review key questions about the first large battery bus order. In particular, the group was ready to recommend on a number of items that were then adopted by the Steering Committee. These items included:



Fleet Planning Steering Committee

Bill Bryant
Service Development
Section Manager

Chris Parrott
Vehicle Maintenance
Division Director

Tim Flanagan
Bus Operations
Division Director

Jonathon Bez
Chair, Fleet Planning
Steering Committee

Bill Thon
Fleet Procurement
Superintendent (acting)

Tina Rogers
Capital Planning
Section Manager

Jill Kreckow
Finance and Administration
Finance Manager

Greg Svidenko
Finance and Administration
Capital Budget Coordinator

Grantley Martelly
Safety and Security
Section Manager

Fleet Planning Working Committee

Danny Iliou
Capital, Zero Emission Fleet

Lisa Shafer
Capital, Base Planning

Dale Hartman
Facilities, Program Manager

Dan Santon
VM, Functional Analyst

Don Goodwin
VM, CSC Superintendent

Carrie Lee
Sustainability Coordinator

Dion Graham
ADA System Administrator

Katie Chalmers
Service Planning Supervisor

Dave VanderZee
Service Planning

4. Subcommittee Report - Locking In On Our First Big Battery Bus Order

At the last meeting the Steering committee had established the following as recommendations for the upcoming battery bus order:

- **THE PLANNED MIX OF THE BATTERY BUS ORDER WOULD BE 50/50 (60 40' COACHES AND 60 60' COACHES) FOR A TOTAL OF 120 COACHES**
- **THE ORDER WOULD INCLUDE A REQUIREMENT FOR 2 PROTOTYPES, 1 40' and 1 60' COACH**
- **COACHES WILL NOT HAVE INTERIOR BATTERY STORAGE**
- **COACHES WILL CONTINUE TO BE SPEC'D TO ACHIEVE A 140 MILE RANGE UNDER WORST CASE OPERATING CONDITIONS**
- **THE ORDER WOULD BE MADE USING THE WSDOT CONTRACT**

At this meeting we took two additional steps:

- **THE NEXT ORDER OF 40' AND 60' BATTERY BUSES SHOULD COME FROM ONE VENDOR**
- **THAT BUILDER SHOULD BE NEW FLYER**

The supporting documentation for these decisions is included as an attachment on the following pages. Participation from the working team included key representatives from Capital, Service Development, Vehicle Maintenance, and Bus Operations.

Bill Thon and Jon Bez will work together to advance this procurement through its final steps of internal approval.

5. Fleet Plan Update

Jon is coordinating with Service Planning and updating the draft fleet planning document for a handoff to Fleet Procurement to vet and document as an official update of the fleet plan. No major changes are expected so far, beyond the changes we've made to the mix of fleet on the upcoming battery bus order. The RapidRide team may also ask for a better call out on their fleet plans in the doc.



Fleet Planning Steering Committee

Bill Bryant
Service Development
Section Manager

Chris Parrott
Vehicle Maintenance
Division Director

Tim Flanagan
Bus Operations
Division Director

Jonathon Bez
Chair, Fleet Planning
Steering Committee

Bill Thon
Fleet Procurement
Superintendent (acting)

Tina Rogers
Capital Planning
Section Manager

Jill Krecklow
Finance and Administration
Finance Manager

Greg Svidenko
Finance and Administration
Capital Budget Coordinator

Grantley Martelly
Safety and Security
Section Manager

Interim Base BEB Procurement Sub-Committee

Jonathon Bez
Katie Chalmers
Jeremy Fichter

Tim Flanagan
Danny Iliolu
Radhika Moolgavkar

Chris Parrott
Lisa Shafer
Bill Thon
Ken Young

MEMORANDUM

Date: July 30, 2019

To: Fleet Planning Steering Committee

From: Interim Base Battery Electric Bus (BEB) Procurement Sub-Committee

Subject: Procurement of Battery Electric Buses to Operate from the new Interim Base

A subcommittee was developed to review the procurement for battery electric buses intended to operate out of the new interim base in 2021. After a series of meetings, the subcommittee developed a set of recommendations. A number of those recommendations were shared and agreed upon at the Fleet Planning Steering Committee on July 10. These are listed at the end.

This memo addresses the question of which vendor(s) for the procurement. The recommendations are below.

1) Select a single vendor for the entire 120 BEB bus procurement

Battery electric bus technology is an emerging field that is quickly evolving. The bus building and transit industries are still establishing standards for equipment and business practices that will ultimately inform this new paradigm of "zero emission" fleets. Metro is pushing toward a goal of a 100 percent zero emission fleet by 2040. To achieve that, there will be many future battery bus procurements in upcoming years. To help simplify Metro's first step toward larger scale transition to battery buses, the subcommittee recommends a single vendor to fulfill this initial order of 40' and 60' battery buses.

Working with a single vendor will reduce the number of variables that need to be monitored with this initial order as the agency becomes more familiar with operating a large fleet of battery electric buses. Using one vendor will simplify the range of parts needed and simplify maintenance and training efforts during the adoption of this new technology. If problems arise or if there are issues of compatibility, Metro will be able to work with a single vendor more quickly to resolve issues.

Metro will continue to test and monitor the performance of other vendors to inform future procurements.

2) Recommended Vendor: New Flyer

Metro has been conducting a test of extended range battery buses from different vendors over the past year. To date, Metro has had the opportunity to test 40-foot buses from Proterra and 40-foot and 60-foot buses from New Flyer. Since Metro will need both 40-foot and 60-foot buses in this order, New Flyer is the vendor that Metro has been able to test, and is able to meet Metro's needs.

Metro will soon begin testing 40-foot and 60-foot buses from BYD. In order to keep Metro on pace to deliver this initial fleet in 2021, it must use data already attained however. The continued testing, including assessment of BYD will provide valuable data that will inform our 2021 operations and future procurements.

Prior Agreed-Upon Recommendations

At the July 10 meeting, the Fleet Planning Steering Committee adopted the following subcommittee recommendations:

- The recommended mix of the battery bus order is 60 40-foot buses and 60 articulated 60-foot buses for a total of 120 buses
- The order should include a requirement for 2 prototypes, 1 40-foot and 1 60-foot bus
- The buses will not have interior batteries
- The specifications for the buses will be to achieve a 140 mile range under worst case operating conditions
- The order will be made using the Washington State Department of Transportation (WSDOT) contract

Charging Infrastructure

The subcommittee also identified the "Pantograph Up" versus "Pantograph Down" charger decision as a critical path item for base design, but that was outside its scope. This topic was deferred to the ZEB/BEB Working Group for discussion and recommendation.

At the July 19 ZEB/BEB Working Group meeting, the group reviewed four charging options. Consensus was achieved that SAE J1939-1 Pantograph Down is the preferred automated solution to be pursued for vehicles and infrastructure. It was also agreed that SAE J1772 CCS Type 1 will be the solution for manually plugging in chargers to support maintenance activities, and as a possible fallback charging option. The discussion also recognized that options may be revisited pending a consultant report and recommendations that are due in August-September.

MEMO

TO: Zero-Emissions Fleet /PCT

FROM: Danny Ilioiu

CC: Program Coordination Team; Tina Rogers; Diane Carlson

DATE: 11/12/2019

RE: Interim at South Base, Inform on Gantry Design as Pantograph Platform



ZEB PROGRAM COORDINATION TEAM

Objective: Inform leadership of a proposed, preferred configuration to mount inverted pantographs. This memo is based on a planning report and on-going design work will provide the final recommendation.

Background: Metro's Capital Planning Division contracted with Parametrix and HELIOX because of their expertise in design and deployment of similarly sized facilities in North America and Europe, including traffic flow studies and base layout optimization to support Metro Operations, Maintenance and Utility requirements.

Report Recommendation: The Parametrix and HELIOX report recommended the gantry design shown below as the preferred option. Additional detail may be found at: "South Base Battery Electric Bus Interim Facility – Conceptual Design Report" managed by Capital Planning with input from other Metro departments.

The proposed gantry configuration resolves the following key elements:

- Provides for maximum number of lanes for bus parking
- Routes all the cabling and connections above within the gantry design for ease of servicing
- Allows for coaches to have standard charging hardware configurations without resorting to opposed direction parking
- Provides a design that can easily scale at South Annex or other bases
- Optimizes the use of above-ground elements to ease delivery, enhance asset maintenance and maximizes recovery of assets at end of Interim Base life

- Danny Ilioiu**
Zero-Emissions Bus Strategic Program Manager
- Jeff Arbuckle/Designee**
Capital Planning Facilities & State of Good Repair
- Kevin Kibet or Ade Franklin designee**
Project Delivery
- Bill Thon/Designee**
Capital Planning Fleet Procurement & Contract Management
- Elie Kourdahi/Designee**
Vehicle Maintenance Fleet Engineering
- Radhika Moolgavkar**
Utility Engagement Special Projects Manager
- Carrie Lee**
Sustainability Program Manager
- Tina Rogers**
Capital Planning Section Manager
- John Bez or Katie Chalmers**
Mobility Service Planning
- Grantley Martelly/Designee**
Safety, Security and Training
- Heather Kitborn/Designee**
Transit Facilities Division Director
- Tim Flanagan/Designee**
Bus Operations Division Director
- Gregory Svidenko or Jessie Wang**
Finance

MEMO

TO: Zero-Emissions Fleet

FROM: Danny Ilioiu

CC: Program Coordination Team; Tina Rogers; Diane Carlson

DATE: 11/12/2019

RE: Interim at South Base, Inform on Gantry Design as Pantograph Platform



ZEB PROGRAM OVERSIGHT GROUP

Diane Carlson – Program Sponsor
Director, Capital Division

John Resha
AGM, Finance & Administration Division

Heather Kilborn
Director, Transit Facilities Division

Chris Parrott
Director, Vehicle Maintenance Division

Chris O'Claire
Director, Mobility Division

Tim Flanagan
Director, Bus Operations Division



Gantry conceptual design and pantograph shown above.

MEMO

TO: Zero-Emissions Fleet /PCT

FROM: Danny Ilioiu

CC: Program Coordination Team; Tina Rogers; Diane Carlson

DATE: 11/12/2019
RE: Interim at South Base Layout of Charging Infrastructure



Objective: Define the optimal layout for parking buses, charging buses, to optimize traffic flow, charging opportunities while maintaining or improving operational safety at the facility. Locate electrical equipment.

Background: Metro's Capital Division contracted with Parametrix and HELIOX to use their expertise in design and deployment of similarly sized facilities, including traffic flow studies and base layout optimization to support Operations, Maintenance and Utility requirements.

Recommendation: The Parametrix and HELIOX report recommended the layout shown below as the preferred option, Additional detail may be found at: "South Base Battery Electric Bus Interim Facility – Conceptual Design Report" managed by Capital Planning with input from other Metro departments.

The proposed layout resolves the following key elements:

- Use similar dispatch process as current
- Centralizes the electrical equipment for ease of servicing
- Reduces coach movements to enhance safety
- Performed traffic flow study similar to a diesel base
- Optimizes the use of above-ground elements to ease delivery, enhance asset maintenance and maximizes recovery of assets at end of Interim Base life
- Fits in the constraints of the existing diesel-hybrid base configuration

ZEB PROGRAM COORDINATION TEAM

Danny Ilioiu
Zero-Emissions Bus Strategic Program Manager

Jeff Arbuckle/Designee
Capital Planning Facilities & State of Good Repair

Kevin Kibet or Ade Franklin designee
Project Delivery

Bill Thon/Designee
Capital Planning Fleet Procurement & Contract Management

Elie Kourdahi/Designee
Vehicle Maintenance Fleet Engineering

Radhika Moolgavkar
Utility Engagement Special Projects Manager

Carrie Lee
Sustainability Program Manager

Tina Rogers
Capital Planning Section Manager

John Bez or Katie Chalmers
Mobility Service Planning

Grantley Martelly/Designee
Safety, Security and Training

Heather Kitborn/Designee
Transit Facilities Division Director

Tim Flanagan/Designee
Bus Operations Division Director

Gregory Svidenko or Jessie Wang
Finance

EXHIBIT B: Zero-emissions Bus Program Governance

ZERO-EMISSIONS BUS PROGRAM GOVERNANCE

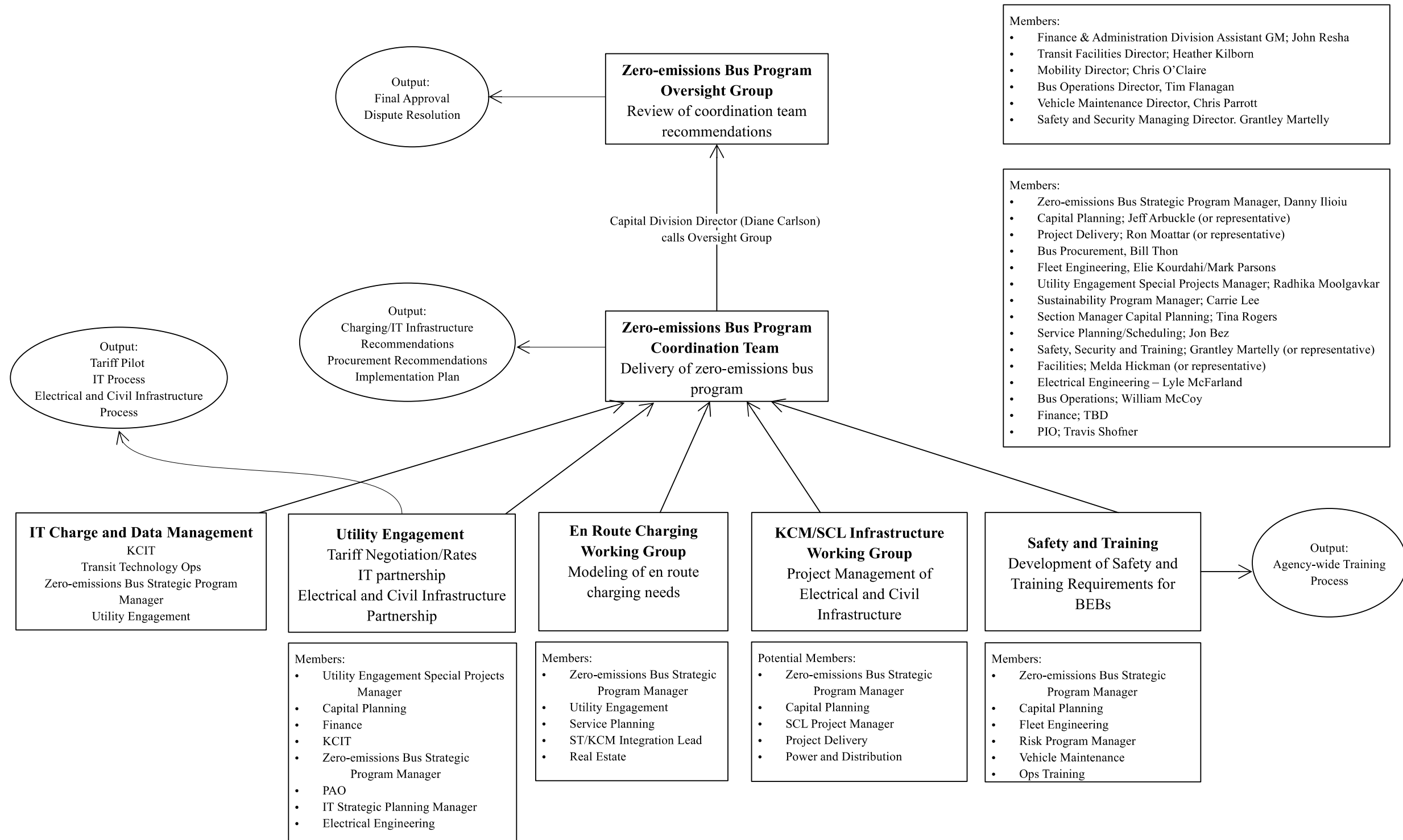

EXHIBIT C: Program Charter



Program Charter: Zero-Emissions Fleet, Bus Electrification Program

Ratification Date:

A. Purpose

The purpose of this charter is to document and authorize the management of King County Metro Transit Department's (METRO) Zero-Emissions Fleet, Bus Electrification Program (Program) to convert our fixed-route fleet to a fully zero-emissions bus fleet by 2040.

B. Background

1. **Business Problem** Meeting King County's commitment for METRO to operate a fully zero-emissions bus fleet by 2040 is a major undertaking. The Program supports the alignment of METRO business processes, capital investments, and workforce development to deliver on this commitment. This change in fleet will impact numerous aspects of METRO's business model and will require effective coordination across the organization with resources, clear roles and responsibilities, and strong leadership.
2. **Program Overview** This Program will develop the body of knowledge and coordinate implementation required to support the transition and operation of the bus fleet from carbon-based fuels to electric power by replacing the diesel and diesel-electric hybrid buses from the 1,500 bus fleet with battery electric buses and electric trolley buses by 2040. Work to accomplish this transition will advance King County's Strategic Climate Action Plan and its Equity and Social Justice Plan. Program work is managed internally to METRO and is coordinated with external stakeholder activities through the process as defined in this charter. The Program resides in the Capital Division and its sponsor is the Director of the Capital Division of METRO.

C. Program Concept

1. **Scope** To plan and coordinate the projects and activities that constitute the successful transition to 100 percent zero-emissions bus operations by 2040 while maintaining alignment with organizational goals¹.
2. **Guiding Principles**
 - a) Commit to the success of the Program and its constituent projects and activities through effective coordination, adherence to decision-making protocols, and transparent risk management
 - b) Create a model of excellence in transit conversion from carbon-based fuels to electric power-based fixed-route public transportation
 - c) Work together to meet our principles of equity and social justice, sustainability, good community partnerships, and access to public transportation as a human right for all of King County
 - d) Build partnerships with utilities and partner agencies to optimize the electrification of transportation while eliminating diesel exhaust criteria air pollutants, as defined by the US EPA, from the routes served
 - e) Provide Capital, Bus Operations, Mobility, Vehicle Maintenance, Transit Facilities, and other METRO Divisions with the knowledge and tools needed to support the successful transition to a zero-emissions fleet
 - f) Plan future facility investments to incorporate the needs of a zero-emissions fleet

¹ MetroConnects, King County's Strategic Climate Action Plan, King County's Equity and Social Justice Plan

Program Charter: Zero-Emissions Fleet, Bus Electrification Program

- g) Identify opportunities and scope grant applications to fund various projects or activities supportive of the transition to zero-emissions operations
- h) Increase the efficiency and cost-effectiveness of METRO operations

3. Key Performance Indicators Key Performance Indicators (KPIs) to measure benefits and set expectations for the Program will be established within six months of the ratification of this charter. KPIs to be considered include:

- Adherence to implementation plan schedule
- Bus availability and reliability
- Charger availability and reliability
- Charger commissioning on schedule
- Safety
- Service cancellations
- Customer acceptance and support
- Greenhouse Gas (GHG) reduction goal attainment
- Cost monitoring

D. Program Management Approach

The Program Manager (PM) is responsible for coordinating the development and implementation of a Program management plan that identifies clear roles and responsibilities, includes an integrated schedule of capital projects and associated operational activities. The PM is also responsible for a risk management plan to monitor existing and to identify emerging actionable Program risks.

1. **Program Governance** The Program governance consists of the PM, the Program Coordination Team (PCT), the Program Sponsor (Sponsor), and the Program Oversight Group (POG). The PM designs, convenes, and chairs the PCT meetings to capture stakeholder and subject matter expert consensus and to coordinate implementation activities across METRO. Escalations of issues from the PCT will be communicated through the PM for action as directed by the Sponsor, which may involve engagement with the POG. The PM is responsible for managing the Program, with the support of the immediate supervisor and the Sponsor, ensuring that the Program goals remain aligned with the overall strategic objectives of METRO.
2. **Program Manager Role** The PM will provide leadership and strategic guidance to the planning, design, coordination, operation and oversight of the projects and initiatives that launch and built the Program. The PM will recommend direction on complex and high-level policy decisions to the Capital Division and to METRO leadership related to the successful transition to zero-emissions bus operations. The PM will coordinate and be responsible for developing the Zero Emissions Bus Transition Plan. The PM will identify and oversee organizational resources to design a means to coordinate the collection and dissemination of data and publication as part of the performance management plan. The PM and the immediate supervisor will manage necessary revisions to the Program charter, and obtain Sponsor approval to support changing goals or strategy as directed by King County. The PM provides the internal- and external-facing leadership and advocacy for the projects and activities that support the implementation of the Program and its goals overall.

Program Charter: Zero-Emissions Fleet, Bus Electrification Program

3. **Program Milestones** The Program Milestones known at the time of charter ratification include:
- a) **2019** Final scope of work for design of Interim Base electrification
 - b) **2019** Development and ratification of a Zero Emissions Bus Transition Plan
 - c) **2019** Issuance of procurement documents for the next 120 battery-electric buses to start deliveries by 2021
 - d) **2020** Completion of long range bus testing
 - e) **2021** Commission battery-electric operations at Interim Base
 - f) **2025** Commission new South Annex Base for battery-electric-only fleet operation
 - g) **2030-2040** Build new South King County Base and convert remaining existing bases for battery-electric-only fleet operation
 - h) **by 2040** METRO bus fleet is 100 percent zero-emissions
- The PM will maintain a current list of Program milestones to monitor and report progress at the Program level.
4. **Current Scope** The current scope is to develop the Zero Emissions Bus Transition Plan (Plan). The Plan will initially guide early implementation steps consisting of design, construction, fleet acquisition, and other activities that develop the blueprint for future standards and requirements for buses, energy storage systems, charging infrastructure, electric-utility modifications, and operations of electric buses which will become the long-term portion of the Plan. The development of the Plan will be reviewed by the PCT chaired by the PM with active participation from various sections within Capital, Mobility, Bus Operations, Vehicle Maintenance, Transit Facilities and other affected METRO Divisions.
5. **Impacts** The current state of METRO's bus operations system (diesel hybrid bus operation supported by trolley buses) and the system constraints will be documented by the PM. Advancing each element to a state of readiness for Program milestones will be the work of the PCT, to include:
- a) Service Model
 - b) Timing/Scheduling
 - c) Training Program
 - d) Documentation Transition to Operations and Maintenance Support
 - e) Stakeholder Communications and Public Engagement
 - f) Operations and Maintenance Planning
 - g) Resiliency and Disaster Recovery Plan
6. **Program Communications Plan** The PM will identify resources best suited to assist in the development and implementation of a Program Communications Plan. The identified team will coordinate with affected METRO Divisions to insure timely and effective communications to internal and external stakeholders.

Program Charter: Zero-Emissions Fleet, Bus Electrification Program

- 7. **Program Risk Register** The PM will develop and conduct a process to gather input to identify and manage Program risks, with regular communication with the PCT and Sponsor.
- 8. **Success Criteria** Performance will be monitored and reported to the POG on the adopted KPIs.

E. Program Organization and Governance

1. Program Coordination Team The PM will convene the PCT at least once per month to coordinate the activities, document decisions, and clarify roles and responsibilities within the team. Each member should have at least one designated alternate to ensure that their group is represented at each meeting, and should replace any members who are unable to continue in their role. Initial membership should include the subject matter experts listed in the table below, with their current roles and responsibilities. Selected members of the PCT will coordinate activities and impacts with the Fleet Planning Steering Committee, RapidRide Program, and other groups, project teams or functions as identified. Membership can be increased and/or updated as staff changes occur. Removal of positions from the membership require approval of the POG.

Member	Function/Responsibility
Strategic Planning Manager, Zero-Emissions Fleet (Capital Division)	Program Manager
Transit Vehicle Procurement Admin, Transit Fleet Procurement and Contract Management (Capital Division)	Bus procurement
Managing Supervisor, Fixed Asset Program Management - Facilities and State of Good Repair (Capital Division)	Facilities planning
Fleet Engineering (Vehicle Maintenance)	Bus test and maintenance training
Logistics/Fleet Planning (General Manager’s Office)	Fleet Plan adjustments
Service Planning (Mobility)	Service routes and blocks adjustments
Electrical Engineering (Capital Division)	Standards proposals
Director, Vehicle Maintenance Division	Requirements proposals
Director, Bus Operations	Operations impacts
Managing Supervisor, Capital Project Delivery Management (Capital Division)	Construction project management
Government Relations Officer, Internal and External Relations & Engagement (General Manager’s Office)	Program communications
Special Projects Manager, Utility Engagement (Capital Division)	Rates coordination with electric utilities SCL and PSE
Section Manager, Capital Planning and Portfolio Management (Capital Division)	Strategy management and program coordination
Project/Program Manager, Sustainability (Capital Division)	Strategy oversight, SCAP Goals alignment, executive office and climate leadership team activities management

Program Charter: Zero-Emissions Fleet, Bus Electrification Program

2. **Program Oversight Group** The Program Sponsor will assess the need for and will convene meetings, provide communication with and/or request approval of recommended actions from the POG. Initial POG Membership includes the signatories to this charter, except for the ratification signatories. POG Membership will automatically change with personnel changes in the designated positions. Attendance or remote participation by more than 50 percent of POG Members will constitute a quorum. Attendance by the Chair and Vice Chair count towards a quorum, but designees of POG Members do not. Decisions will be made by consensus of the POG Members present at the meeting, provided there is a quorum. If there is not a quorum, decisions are advisory only and a quorum of POG Members at a future meeting will need to reach a consensus to formalize a decision. If consensus cannot be reached by the POG Members, the item will be forwarded to the ratification signatories for resolution.
 3. **Roles & Responsibilities** The PM will develop and maintain, with the input of the PCT, a chart identifying all critical Program activities and projects in greater detail than the table above. The chart will also indicate the name of the person holding the position title of the responsible party along with all support, consulting, and affected stakeholder roles. Any PCT member with activities that may require charter change must alert the PM and together recommend changes to the members of the PCT for approval.
- F. **Charter Approval and Maintenance**
1. **Change Procedures** The PM will develop a change management procedure to keep the charter a functioning document, including review and input from the PCT. Revisions to the charter require approval by the Sponsor. The Sponsor may elevate the charter change for approval by the POG.
 2. **Charter Approval** The charter is approved when all the signatories provide concurrence by signing this charter and is ratified when signed by the General Manager and Deputy General Manager.

EXHIBIT D: Bus Procurement Process

KING COUNTY METRO – ALTERNATIVE CONTRACT MECHANISM BUS PROCUREMENT FLOWCHART

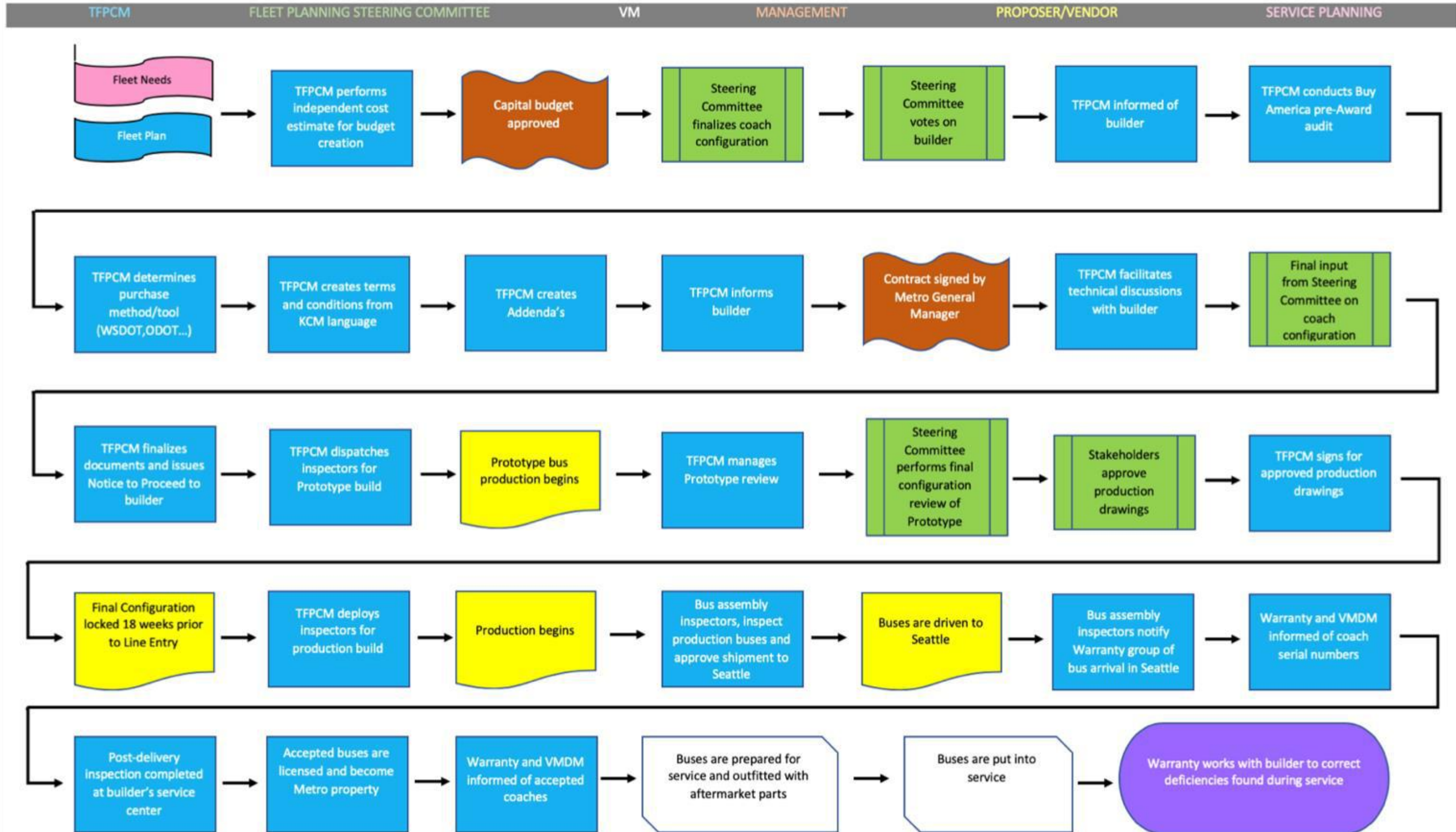

EXHIBIT E: Form of Green Building Ordinance

Form of Green Building Ordinance

Project Name: Metro Transit ZEB Program

Project Number:

Project Manager:

Current Phase:

Scorecard

Scorecard					
	Y	NA	Required	Comments	
	X		Prereq 1 Hold an eco-charrette or similar meeting		
	X		Prereq 2 Use Life Cycle Cost Assessment		
	X		Prereq 3 Account and mitigate for greenhouse gas emissions		
	X		Prereq 4 Implement erosion and sedimentation control best management practices		
		X	Prereq 5 Meet the equivalent energy performance of the most progressive code in King County	Limited application, focused only on lighting or other associated equipment. Potentially differences in charging equipment options.	
	X		Prereq 6 Install water saving fixtures		
	X		Prereq 7 Implement Green O&M program, including green cleaning program	TBD	
Y	M	N	NA	Planning and Designing for Sustainable Development	Comments
X				PD 1.0 Use an integrative design process	Yes
X				PD 2.0 Use "green" contract language and specifications	Yes
			X	PD 3.0 Develop on brownfield sites	Potentially applicable but depends on site
			X	PD 4.0 Plan and design for long-term maintenance	
X				PD 5.0 Plan and design for long-term maintenance	Likely
X				PD 6.0 Design for Disassembly	Likely
X				PD 7.0 Plan, design, and build with pre-fabricated elements	Likely
X				PD 8.0 Plan for efficient construction delivery and staging	

Y	M	N	NA	Construction Best Management	Comments
X				CM 1.1 Recycle construction and demolition materials : 50% diverted	King Co goal
X				CM 1.2 Recycle construction and demolition materials : 75% diverted	King Co goal
X				CM 1.3 Recycle construction and demolition materials : 95% diverted	Should be attainable esp. for concrete etc.
	X			CM 2.0 Use on-site materials in construction	Potentially onsite concrete for fill
	X			CM 3.0 Use alternative fuels in construction equipment	
			X	CM 4.0 Implement indoor air quality construction management plan	
	X			CM 5.0 Reduce water use for cleaning and dust control	
Y	M	N	NA	Preserve and Maintain Natural Site Amenities	Comments
X				SA 1.0 Minimize development footprint	
	X			SA 2.0 Preserve existing native vegetation	Depending on site conditions and location (e.g. site of en route charger in location that will not disturb existing vegetation)
	X			SA 3.0 Retain or create open space and corridors	Depending on site conditions and location (e.g. site of charger or base in location that will not disturb existing open space corridor)
	X			SA 4.0 Reuse native soils on-site	Depending on site conditions (e.g. avoid need to bring in soil to regrade for charging or gantry foundations etc.)
	X			SA 5.0 Use light-colored exterior surface treatments – roof and non-roof	Consideration of surface if mezzanine design atop gantry is considered.
	X			SA 6.0 Integrate vegetated roofs and green areas	Potentially applicable if part of comfort station or supervisor remote desk

X				SA 7.0 Design lighting for reduced light pollution	
	X			SA 8.0 Design natural acoustic buffers	Could be applicable to base design, but not likely to be specific to ZEB infrastructure.
Y	M	N	NA	Reduce Energy Use and Promote the Use of Renewable Energy	Comments
X				EN 1.0 Use LED lighting and occupancy/daylighting controls throughout facility	Lighting of yard could be sensor occupancy controlled. Yard lighting likely to be integrated into charging design.
	X			EN 2.1 Reduce energy use: 10% reduced, beyond most progressive current code	Unlikely but energy code should be considered.
	X			EN 2.2 Reduce energy use: 20% reduced, beyond most progressive current code	Unlikely but energy code should be considered.
	X			EN 2.3 Reduce energy use: 30% reduced, beyond most progressive current code	
	X			EN 3.1 Install on-site renewable energy: Install 25% on-site renewable energy sources	If solar panels were installed above charging gantry this could be an option. Unknown what % of renewable energy for facility could be generated. Renewable energy % would not be applicable to power needed for fleet, but instead facilities. Need to revise for this.
	X			EN 3.2 Install on-site renewable energy: Install 50% on-site renewable energy sources	
	X			EN 3.3 Install on-site renewable energy: Install 75% on-site renewable energy sources	
	X			EN 3.4 Install on-site renewable energy: Install 100% on-site renewable energy sources	
			X	EN 4.0 Use only Energy Star certified appliances or equipment as applicable	Unlikely that Energy Star equipment exists for charging, but possible.
X				EN 5.1 Verify energy efficiency in commissioning	This is only applicable to building infrastructure.
X				EN 5.2 Develop ongoing or re-commissioning plan	
X				EN 5.3 Provide energy monitoring and sub-metering	Likely to be integral to charge management system

X				EN 6.0 Apply for Energy Utility Rebates	Partnerships with utilities will be integral to these programs. Not in the traditional sense of rebates for energy conservation, but around supporting electrification of vehicles.
X				EN 7.0 No onsite fossil fuel combustion, other than back-up generators	To the degree the facility is all-electric and does not include fuel bldg nor back-up diesel generator.
X				EN 8.0 Innovation Credit	Likely opportunity as Metro leadership around charging and on-demand energy management. Will need to document specifically how e.g. sharing lessons with other transit partners and utilities.
Y	M	N	NA	Water Management	Comments
	X			WM 1.1 Treat 50% stormwater through LID techniques	Assumes this applies to the site design and not applicable to the ZEB infrastructure specifically. However, potential to consider how using ZEB vs diesel hybrid fleet reduces loads of pollutants and improves water quality.
	X			WM 1.2 Treat 75% stormwater through LID techniques	
	X			WM 1.3 Treat 100% stormwater through LID techniques	
	X			WM 2.0 Install high efficiency irrigation systems	
	X			WM 3.0 Install rainwater collection system	In theory a gantry system with a mezzanine could include some type of water collection.
	X			WM 4.0 Plant drought resistant native species to eliminate need for irrigation	
Y	M	N	NA	Use of Sustainable Materials	Comments
	X			SM 1.0 Use low-emitting materials, 100% of adhesives & sealants used	To the degree this is applicable. ZEB chargers at eastgate did not include.

	X			SM 2.0 Use low-emitting materials, 100% of paints used	To the degree this is applicable. ZEB chargers at eastgate did not include.
	X			SM 3.1 10% materials sourced from within 500 miles	Materials can be 500-mile radius of product and comprise at least 10% of the materials.
	X			SM 3.2 Heavy materials sourced from within 500 miles	
	X			SM 3.3 Plants sourced within 250 miles	Vegetation likely to be more applicable to site design than ZEB infrastructure, but potential more relevant for an en-route charger project
	X			SM 4.0 Use high recycled-content materials	
	X			SM 5.0 Use FSC certified sustainable wood	Applicable only if wood part of design, maybe relevant for en-route charger if benches or other amenities are a part of design.
	X			SM 6.0 Use renewable materials	Applicable only if wood or other materials are part of design, maybe relevant for en-route charger if benches or other amenities are a part of design.
	X			SM 7.0 Use cement substitutes	Potentially applicable to en-route sidewalks or base design.
	X			SM 8.0 Reuse salvaged materials	Unlikely to be appropriate
Y	M	N	NA	Enhanced Performance	Comments
	X			EP 1.1 Performance Reporting of Prerequisite 5	
			X	EP 1.2 Performance Reporting of Prerequisite 6	
	X			EP 1.3 Performance Reporting of Prerequisite 7	
X				EP 1.4 Performance Reporting of Any Credit	
X				EP 2.0 Submit Supporting Documentation	
	X			EP 3.0 LEED Accredited Professional	
Y	M	N	NA	Equity and Social Justice	Comments

X			ESJ 1.1 Develop a project-specific ESJ plan: 3 ESJ determinant/credits	Programmatic plan will count for this credit.
	X		ESJ 1.2 Develop a project-specific ESJ plan: 6 ESJ determinant/credits	Programmatic plan will count for this credit.
X			ESJ 2.1 Stakeholder partnering & collaboration: Informs, consults, X dialogue	Stakeholders include can community and employees.
	X		ESJ 2.2 Stakeholder partnering & collaboration: Work together, directs actions	
X			ESJ 3.1 Diversity in project and design teams: include ESJ expertise	Can put in ESJ innovation plan to encourage consultants/contractors
	X		ESJ 3.2 Diversity in project and design teams: decision making role	
X			ESJ 4.1 Conduct equity impact review: scope and assess	
	X		ESJ 4.2 Conduct equity impact review: use EIR info for pro-equity decisions	
X			ESJ 5.1 Site, design, and construct to counter disparities: 2 efforts	Already sited to counter disparity; can design to eliminate further disparities.
	X		ESJ 5.2 Site, design, and construct to counter disparities: 4 efforts	
	X		ESJ 5.3 Site, design, and construct to counter disparities: 6 efforts	
	X		ESJ 5.4 Site, design, and construct to counter disparities: 8 efforts	
X			ESJ 6.1 Realize priority elements of ESJ plan: 2 efforts	Depends on what's in plan - this is the accountability. Need to figure out when this will be reported/measured.
X			ESJ 6.2 Realize priority elements of ESJ plan: 4 efforts	
	X		ESJ 6.3 Realize priority elements of ESJ plan: 6 efforts	
	X		ESJ 6.4 Realize priority elements of ESJ plan: 8 efforts	
X			ESJ 7.1 Advance economic justice: meet apprenticeship & SCS req	Priority hire; creating jobs pathway: ESJ innovation plan; equitable sourcing; linking tech to job training
			ESJ 7.2 Advance economic justice: 1-3% above apprenticeship & SCS req	Work with City Light; partnership contracting (negotiate with partners) and our own contracting.
	X		ESJ 7.3 Advance economic justice: 4-6% above apprenticeship & SCS req	

	X			ESJ 8.1 Pro-equity sourcing: 10%	Possible to locally source some of the material?
	X			ESJ 8.2 Pro-equity sourcing: 11-20%	
	X			ESJ 8.3 Pro-equity sourcing: more than 20%	
X				ESJ 9.1 Innovation credit: specify in comments	Engineering/Project Management Meeting
	X			ESJ 9.2 Innovation credit: specify in comments	Consultant Meeting
	X			ESJ 9.3 Innovation credit: specify in comments	
	X			ESJ 9.4 Innovation credit: specify in comments	
X				SB 10.0 Create public amenity	Can we do some kind of informational displays about ZEB? Can we create an electric Lego bus? Can we create charging stations?
Total Project Yes Points:					
Total Project Maybe Points:					
Total Potential Points:					
Total Possible Points:					
Bonus Points:					
Percent of Total Possible:					
Sustainability Achievement Level:					

EXHIBIT F: Communications Plan

Metro's transition to battery-electric bus fleet

Summary

This document is intended to be a living document and serves to facilitate communication planning intended for long-term communications for battery-electric bus fleet efforts. It identifies existing tools, audiences, and message. A production status table exists at the end to track existing and new efforts, assignments, and the status of products.

Please note: Crossover communication between battery-electric bus team and the OCG group are not reflected here and should involve coordinated efforts between both groups to properly delineate workflow and products.

Background

In 2015, the King County Council adopted the Strategic Climate Action Plan, a blueprint to reduce emissions from county services and operations and prepare for the impacts of climate change. Metro's role is to expand and improve products and services to grow transit ridership, ease traffic congestion, and reduce single-occupancy vehicles. The Strategic Climate Action Plan and Metro's Sustainability Plan sets targets and priority actions for reducing emissions and increasing efficiency. Those targets are:

- 25 percent reduction in greenhouse gases by 2020;
- 50 percent reduction by 2030; and
- 80 percent reduction by 2050.

To reach that level of reduction, Metro has the following targets:

- Increase ridership to up to 225 million boardings by 2040;
- Grow transit service through 2020 with no increase in greenhouse gas emissions;
- Increase the use of alternative fuels in Metro's fleet by 10 percent by 2025;
- Reduce energy use of all Metro fleet vehicles by 10 percent by 2020; and
- Reduce air pollutant emissions from the bus fleet by 10 percent per vehicle miles traveled by 2015.

In 2017, King County Metro pledged to begin purchasing battery-electric buses by 2020, with the end goal of achieving a battery-electric bus fleet by 2040. Since that pledge, Metro has evaluated three separate vendors and began initial planning for construction of Interim Base at South Campus.

Milestones

- Procurement order of 120 battery-electric buses (2020)
- Delivery of battery-electric buses (2021)
- Opening of Interim Base (2021)
- Opening of South Annex Base (2025)
- Opening of South King County Base (2030)

Communications Overview

Objective

Update existing communication tools to reflect current status of battery-electric bus fleet and plans for electrification of Interim Base and South Annex Base. Communicate internally and externally about milestones and future efforts as relates to the battery-electric bus fleet.

Audiences

- General public
- Employees
- South Campus Base-area communities
- South King County Base-area communities
- News media
- Policymakers
- Utility companies
- Other transit agencies
- Environment and energy advocates, stakeholders

Message

King County Metro is leading the industry by being an early adopter of a battery-electric bus fleet. Electric buses produce no exhaust, are quieter, and can lower operating costs. Metro has committed to moving to a 100% battery-electric fleet powered by renewable energy by 2040. That commitment helps King County in the plan to combat the climate crisis by reducing the regional greenhouse gas emissions that come from transportation.

Taking action that makes change will protect our climate, air quality, and health of our communities while providing high-quality, efficient public transportation.

That means new battery-electric buses operating from south King County, improving air quality first in communities where people are disproportionately affected by pollution. It also means retrofitting existing bases and building new

bases that house and maintain battery-electric buses, starting with Interim Base in 2021, South Annex in 2025, and South King County Base in 2030.

Metro continues to lease and test 40- and 60-ft long-range battery-electric buses to assess the performance and reliability in our geography, traffic, and weather conditions. Those assessments help inform Metro's first order of 120 battery-electric buses for use in south King County.

In preparations for operations from Interim Base, Metro is working with suppliers, utilities, and the battery-bus industry to accelerate the adoption of standards for charging methods in order to reduce capital investments and operating expenses.

Metro will lead the way as battery-electric buses become part of the non-polluting vehicle ecosystem around the world. We are paving the path for other metropolitan regions to follow through hard work and ingenuity.

Tools

Battery-electric bus fleet website

- Include a public version of implementation report in PDF
- Current status overview of implementation
- Add technical FAQ
- Add site tour plan
- Add overview one-pager
- Add updated timeline
- Add related information for sustainability and the SKC base
- Add video

Overview one-pager

A one-page handout explaining Metro's steps and goals in transitioning to a battery-electric bus fleet, including a timeline of past and anticipated future events.

Technical FAQ

A one-page handout that answers why Metro is transitioning to battery-electric bus fleet, how the fleet will roll out, how buses are charged, what the range and battery size is, and how Metro is building infrastructure.

Site tour plan

The battery-electric bus team manager receives requests for tours of facilities and battery-electric buses primarily from transit agencies, private companies, media, and students. A site tour plan provides options to determine necessary steps to

facilitate tours, including arranging transportation, handouts and materials, goals, and an itinerary.

News media

Announcements and/or media events as needed for milestones.

Employee update

Communication to staff from Diane, Rob, or battery-electric bus team about milestones (quarterly).

Executive & Council update

Communication to King County Executive and Councilmembers from Diane, Rob, or battery-electric bus team about milestones

Community engagement

Battery-electric bus team engaging with community at local meetings, high-profile events, and other public opportunities to answer questions and share vision of battery-electric bus fleet. Engagement should include community-centered, collaborative engagement that includes working with community-based organizations to gather input, including non-traditional methods to ensure greater participation by people of color, low-income individuals, and people with limited English proficiency.

Social media

Occasional posts on social media, including Metro Matters blog, as appropriate to celebrate milestones.

Video

Educational video on Metro's transition to battery-electric bus fleet (promoted internally and externally).

Other communications tools and staff efforts

- Consistent branding for team memo and PowerPoint presentations.
- Incorporate messaging into town halls, training, onboarding, other county events or opportunities.

- Educate county stakeholders, including the Executive Office, King County Councilmembers.

Production status

Action	Lead	Status
NEWS MEDIA		
News release for procurement decision	PIO	Not started
News release for South Base Charger projects	PIO	Not started
News release for procurement delivery	PIO	Not started
News release for SKC base site selection	PIO	Not started
News release for Interim Base opening	PIO	Not started
PRODUCTS		
Website	Strategic Comms	On-going
Overview one-pager	Strategic Comms	Complete
Technical FAQ	Strategic Comms	Complete
Video	Strategic Comms	
Employee Update (Q4 2019)		
Employee Update (Q1 2020)		
Employee Update (Q2 2020)		
Employee Update (Q3 2020)		
Employee Update (Q4 2020)		
Community Engagement		
Site Tour Plan	Strategic Comms	Complete

APPENDICES

APPENDIX A: Electric Vehicle Charging Description

Understanding Electric Vehicle Charging

It is helpful to compare electric vehicle charging to that of filling up a gas tank with a gasoline pump. In the gas tank example, the primary factors to consider to understand how long it will take to fill the tank are the capacity of the tank (in gallons) and the rate at which the gas is being delivered to the tank (in gallons per minute).

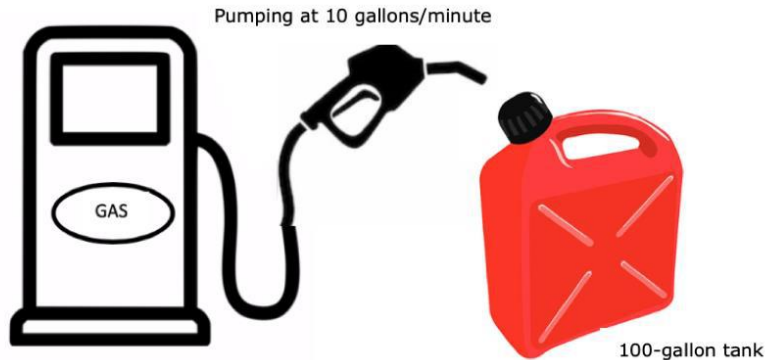

- How long will it take to fill the tank from empty?
 - $100\text{-gallon tank} \div 10 \text{ gallons per minute} = 10 \text{ minutes}$

In the case of electric charging, the gasoline is replaced by an electric charge and the tank is replaced by a battery. The **POWER** (rate) at which the charge is being delivered to the battery is 50 kilowatts (kW). The battery has the capacity to hold 500 kilowatt-hours (kWh) of **ENERGY**.

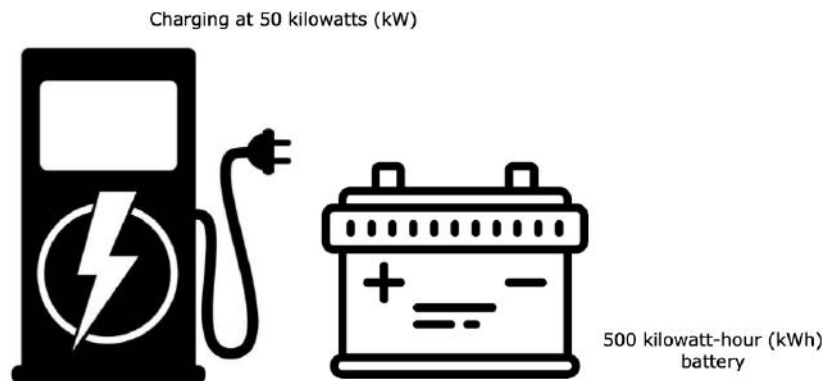

- How long will it take to charge the battery from empty?
 - $500 \text{ kWh battery} \div 50 \text{ kW} = 10 \text{ hours}$

Note: This is a simplified view to illustrate the concepts. As described in the "Battery Electric Bus Primer" section, during the charging process the battery pack and charger are in constant communication, and the amount of power output from the charger varies at any given time according to the battery's capability. Therefore, predicting charging time is more complex than a one-time application of the above equation.

APPENDIX B: Conceptual Interim Base Layout

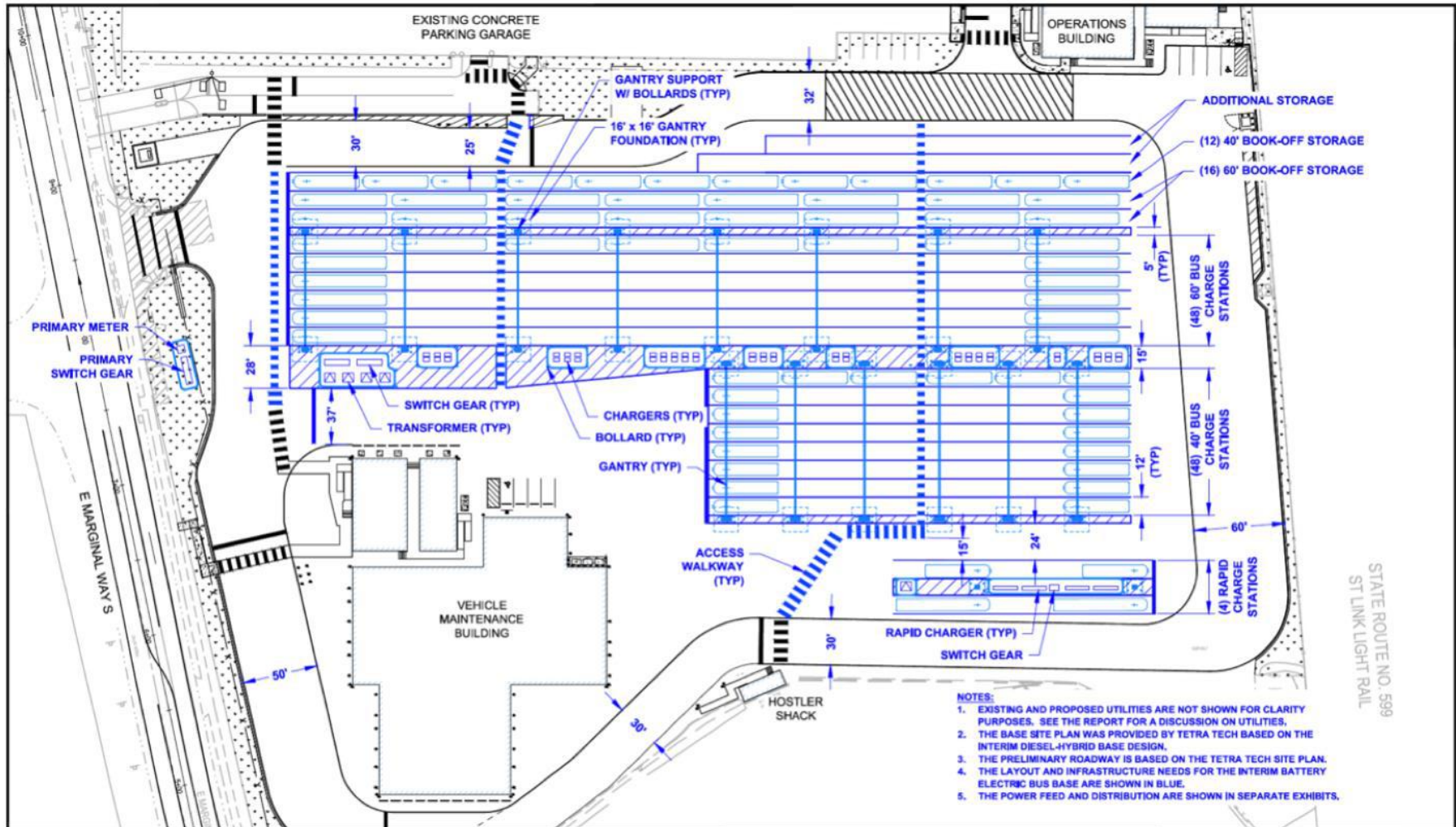

Parametrix DATE: June 26, 2018 FILE: SOUTHBASE BEB LAYOUT OPT 2



King County Metro Transit
South Base
Battery Electric Bus Program - Interim Facility
Layout Concept 2
Truss Bridge Gantry Structures
(100 charging positions : 48 chargers & 4 rapid chargers)

APPENDIX C: Potential Interim Base Routes

Potential Interim Base Routes

AM Assignment Summary (Informs Mid-Day Charge Requirement)				
Coach Type	Assignments	Distance (miles)	Slow Charge Recharge Time (Minutes)	Routes
40'	31	2,018	3,459	116, 154, 156, 157, 159, 177, 179, 180, 181, 182, 186, 187, 190, 192, 197
60'	69	4,579	7,849	101, 102, 111, 116, 143, 150, 157, 158, 159, 177, 178, 179, 180, 190, 192, 193, 197
Total	100	6,597	11,308	101, 102, 111, 116, 143, 150, 154, 156, 157, 158, 159, 177, 178, 179, 180, 181, 182, 186, 187, 190, 192, 193, 197
PM Assignment Summary (Informs Overnight Charge Requirement)				
Coach Type	Assignments	Distance (miles)	Slow Charge Recharge Time (Minutes)	Routes
40'	32	2,383	4,085	22, 116, 153, 154, 156, 157, 158, 159, 168, 169, 177, 179, 180, 181, 182, 183, 186, 187, 190, 192, 193, 197
60'	68	5,130	8,795	101, 102, 111, 116, 143, 150, 157, 158, 159, 177, 178, 179, 180, 190, 192, 193, 197
Total	100	7,513	12,880	22, 101, 102, 111, 116, 143, 150, 153, 154, 156, 157, 158, 159, 168, 169, 177, 178, 179, 180, 181, 182, 183, 186, 187, 190, 192, 193, 197
Total Daily Assignment Summary				
Coach Type	Assignments	Distance (miles)	Slow Charge Recharge Time (Minutes)	Routes
40'	63	4,401	7,544	22, 116, 153, 154, 156, 157, 158, 159, 168, 169, 177, 179, 180, 181, 182, 183, 186, 187, 190, 192, 193, 197
60'	137	9,709	16,644	101, 102, 111, 116, 143, 150, 157, 158, 159, 177, 178, 179, 180, 190, 192, 193, 197
Total	200	14,110	24,188	22, 101, 102, 111, 116, 143, 150, 153, 154, 156, 157, 158, 159, 168, 169, 177, 178, 179, 180, 181, 182, 183, 186, 187, 190, 192, 193, 197

APPENDIX D: SAE Standards

SAE Standards: Summary and Status

SAE Standards are intended as guides toward standard practice. In this rapidly developing industry, these documents are subject to change to keep pace with technical advances and also to harmonize with international standards. Based on the decisions made by King County Metro regarding charging technology to be utilized, there are two applicable SAE documents summarized in this appendix.

The SAE J1772 is a Surface Vehicle Standard entitled "SAE Electric Vehicle and Plug in Hybrid Electric Vehicle Conductive Charge Coupler." It describes the electrical and physical interfaces between the vehicle and supply equipment to facilitate conductive charging in a plug-in configuration. The document also contains functional and performance requirements for these systems. This is applicable to the plug-in depot charger technology King County Metro has selected. As of the writing of this report, the current published revision is dated Oct 2017.

The SAE J3105 is a Surface Vehicle Recommended Practice entitled "Electric Vehicle Power Transfer System Using Conductive Automated Connection Devices." This document is the overarching document that describes various connection standards for what are commonly referred to as "overhead" chargers. These systems typically allow for connection and charging of the vehicle battery in a shorter time frame than plug in chargers and can be utilized while the vehicle is on a revenue service route or at a base and can be connected without the operator leaving his/her seat. The main document contains the common requirements for all connection types, and there are sub-documents that cover specific connection types.

The applicable sub-document is J3105-1 is subtitled "Infrastructure-Mounted Pantograph (Cross-Rail) Connection" and details the specific pantograph-down configuration that King County has chosen. This document contains the functional and physical requirements of the roof mounted rail structure on the vehicle (and associated patch antenna), as well as the infrastructure mounted connection apparatus. Furthermore, the document provides specific connection configuration information, including current and voltage ratings as well as other vehicle structural requirements. As of the writing of this document, the current version is in Proposed Draft form dated September 27, 2019 and is in the approval process. Please contact SAE (www.sae.org) for more information regarding projected availability.

SAE licensing prohibits the distribution of copies of these documents in any form, print or electronic. Therefore, they are not attached here but can be obtained at the SAE's website (www.sae.org).

APPENDIX E: Proposed South Annex Base Construction Timeline

Proposed South Annex Construction Timeline

TASK NAME	DURATION	START	FINISH
South Annex (SA) – Permanent Base	1900 days	Mon 6/4/18	Fri 9/12/25
Planning	260 days	Mon 6/4/18	Fri 5/31/19
SA Conceptual Design	260 days	Mon 6/4/18	Fri 5/31/19
Design	745 days	Mon 6/3/19	Fri 4/8/22
SA Design Scope Development	40 days	Mon 6/3/19	Fri 7/26/19
SA Design Contracting/Tendering/Award	130 days	Mon 7/29/19	Fri 1/24/20
SA Predesign (0%-30% Design)	130 days	Mon 1/27/20	Fri 7/24/20
SA Design (30%-90% Design)	250 days	Mon 7/27/20	Fri 7/9/21
SA Permitting	130 days	Mon 7/12/21	Fri 1/7/22
SA Final Design (90%-100%)	65 days	Mon 1/10/22	Fri 4/8/22
Relocation	497 days	Fri 11/2/18	Mon 9/28/20
Safety & Training Lease Negotiation	130 days	Mon 3/4/19	Fri 8/30/19
Safety & Training Facility Leased	0 days	Mon 9/2/19	Mon 9/2/19
Safety & Training Leased Facility Fit-Out	130 days	Tue 10/1/19	Mon 3/30/20
Safety & Training Move	21 days	Tue 3/31/20	Tue 4/28/20
South Construction Relocation Procurement	216 days	Fri 11/2/18	Fri 8/30/19
South Construction Facility Purchased	0 days	Fri 8/30/19	Fri 8/30/19
South Construction Leased Facility Fit-Out	260 days	Mon 9/2/19	Fri 8/28/20
South Construction Move	21 days	Mon 8/31/20	Mon 9/28/20
All Facilities Cleared	0 days	Mon 9/28/20	Mon 9/28/20
Demolition	260 days	Tue 9/29/20	Mon 9/27/21
Safety & Training Demolition	130 days	Tue 9/29/20	Mon 3/29/21
South Construction Demolition	130 days	Tue 9/29/20	Mon 3/29/21
Site Demolition	130 days	Tue 3/30/21	Mon 9/27/21
Construction	880 days	Mon 1/10/22	Fri 5/23/25
SA Construction Contracting/Tendering/Award	130 days	Mon 1/10/22	Fri 7/8/22
SA Construction	750 days	Mon 7/11/22	Fri 5/23/25
Commissioning and Turnover	80 days	Mon 5/26/25	Fri 9/12/25
SA Commissioning	20 days	Mon 5/26/25	Fri 6/20/25
SA Training	20 days	Mon 6/23/25	Fri 7/18/25
SA Trial Operations	40 days	Mon 7/21/25	Fri 9/12/25

APPENDIX F: Charge Analysis Summary

Charging Analysis Summary

The charging analysis was performed by the Center for Transportation and the Environment (CTE) for King County Metro. The following is a summary of the analysis prepared by CTE.

The aim of this analysis was to demonstrate the effect of charge scheduling on energy use, power and cost and what method is most effective for Metro’s specific requirements.

This analysis assumes the base has 48 x 150 kW chargers and 4 x 300 kW chargers. It also assumes energy and demand requirements for 100 buses running on 100 morning blocks paired to 100 evening blocks. These blocks were chosen specifically by King County for this analysis. It assumes a standard 30 minute delay between bus pull in and charging start to accommodate cleaning, parking, charging setup, etc. Costs shown in Table 1 are combined demand and energy costs using Seattle City Light’s Tukwila Large General Service January 2020 rates; on-peak times are from 6 AM to 10 PM. Costs are calculated using weekday blocks only, assuming an average of 22 weekdays per month.

Scenario	Max Demand On-Peak (MW)	Max-Demand Off-Peak (MW)	Max # Chargers	Monthly Energy On-Peak (kWh)*	Monthly Energy Off-Peak (kWh)*	Annual Cost
1. No Charge Management	9.5	3.3	76	1,014,962	184,118	\$1,825,958
2. Minimized Demand, No Charging 5-10 PM	4.3	4.6	35	576,767	622,315	\$1,400,804
3. Levelized Demand	4.1	4.1	36	873,359	325,722	\$1,505,712

*Estimated average numbers of weekdays per month

Table 1. Charging Analysis Results

Charge scheduling is achieved by adding additional delay time to the charge start. This reduces the number of chargers operating simultaneously. Grid electrical demand is proportional to the number of chargers operating at once, therefore if the number of chargers operating simultaneously can be minimized, demand costs are reduced. Additional cost savings can be found by offsetting charging to occur off-peak, avoiding higher on-peak costs.

Scenario 1: “No Charge Management” demonstrates how charging would occur without any intervention. As expected, this scenario has the highest demand and total cost because it does not avoid on-peak energy and demand costs. This scenario utilizes 9.5 MW of on-peak demand, 3.3 MW of off-peak demand and would cost an estimated \$1.8 million per year. This scenario also requires a maximum of 76 chargers, which is more than is available.

Scenario 2: “Minimized Demand” offsets all evening blocks to begin charging at 10 PM, when additional on-peak charges are not in effect. Morning and evening charging is also distributed over a longer period of time than in Scenario 1, to minimize the number of chargers in use simultaneously, and therefore minimize electrical demand. This method reduces on-peak demand to 4.3 MW, off-peak demand to 4.6 MW and total annual cost to about \$1.4 million, and only requires a maximum of 35 chargers.

Scenario 3: “Levelized Demand” uses a pairing algorithm to achieve the lowest demand. Bus blocks are “partnered”; a bus with a later pull in is partnered to a bus with an earlier pull in. The later bus will not begin charging until the earlier block is complete. This approach minimizes the overall demand by limiting the number of buses charging simultaneously; however, it does not avoid charging during on-peak times. As a result, the total annual estimated cost is still higher than in Scenario 2, at an estimated \$1.5 million, but max demand is reduced to 4.1 MW during both on-peak and off-peak times using a maximum of 36 chargers.

Figure 1 below shows the effect of charge management on electrical demand throughout the day. Scenario 1 has short, tall peaks in the morning and evening when buses pull in. Scenarios 2 and 3 spread the peaks out over a longer period of time to reduce demand. Scenario 2 also delays evening charging to begin at 10 PM to avoid on-peak costs, where Scenario 3 does not.

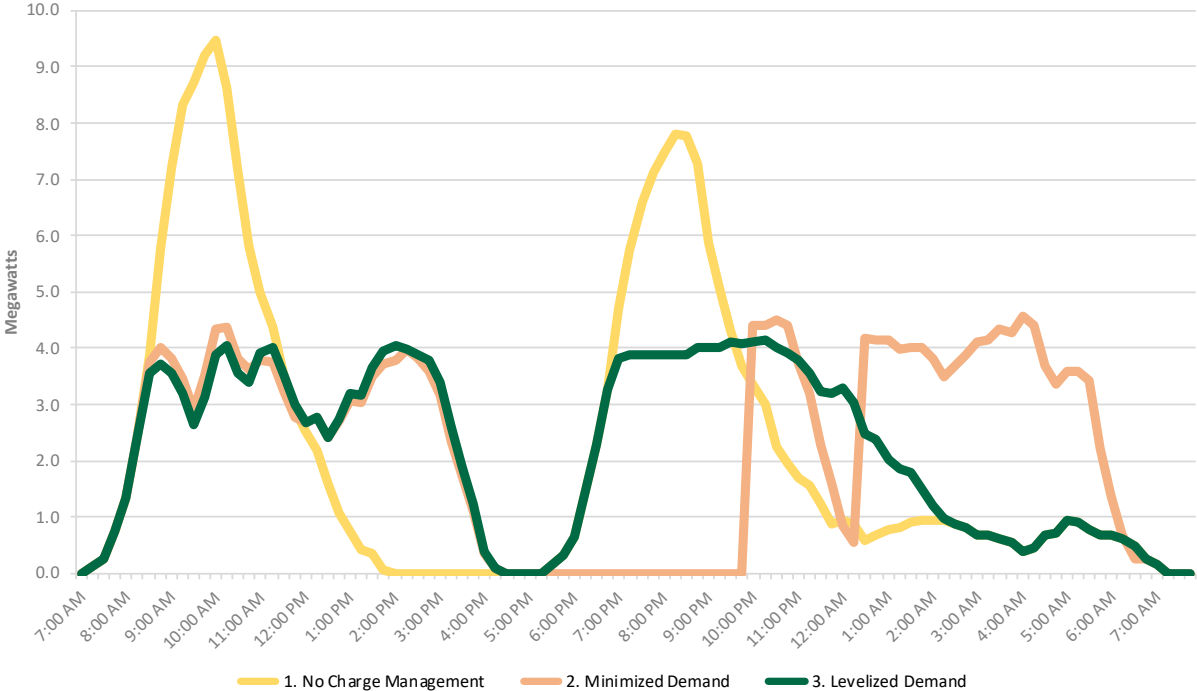

Figure 1. Charging Demand Over One Day, Scenarios 1-3

APPENDIX G: Charging Infrastructure Illustrations

Typical Charging Infrastructure Components

Charging infrastructure and layout can vary substantially across different operators due a number of factors, including: charging technology chosen, size of electric vehicle fleet, real estate available, policies regarding redundancy and back-up generation, operational flow considerations, and locations of charging (depot only versus locations on route, etc.), budget and future expansion plans, among other considerations. The pictures below are for educational purposes only, as an aid in familiarizing stakeholders with the types of hardware that might be included in a charging infrastructure similar to what King County Metro is considering in their future plans.

Transformers

Photo A shows a typical transformer as well as the marker where underground conduit will approach and connect with the unit. Photo B shows a transformer (left) next to a pad where switchgear and charger cabinets will be installed.



Switchgear

Photo's C and D are typical switchgear structures. Photo D shows switchgear (gray enclosures on right) installed in front of charger cabinets- transformer from Photo B is on the left side of this picture.



Charger Cabinets

These house the charger power and control systems. Photo E shows a single charger cabinet, while photo F is a series of them.



Charge Dispensers (Overhead, Conductive)

Photo G is the current gantry mounted blade charging (Proterra) present at Eastgate. Photos H and I are other examples of pantograph-down configurations.



Gantries

Photos J and K are typical gantry structures. Charger style is pantograph-up (different than King County Metro's selected configuration of pantograph-down)



Charge Dispensers (Depot, Plug-In)

Photo L is of a series of dispensers installed at a depot outside lot. Photos M is an integrated charger and dispenser. Photo N is a dispenser with an adjacent cabinet.



Other Components (Power Switch, Backup Generation)

Photo O is a transfer switch that allows the operator to switch from grid power to backup power. Photo P is of a backup generator (raised structure on left. Item on bottom right is a transformer. Photo Q shows the electrical feeders at KCM South Campus.

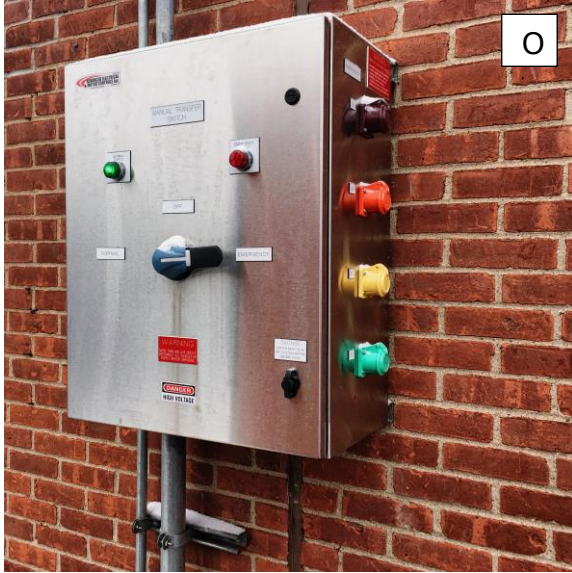

APPENDIX H: DC-As-A-Service Presentation

DC as-a-Service: DOE and SPN

and related activities

Watson Collins
Technical Executive

Bus and Truck
June 11, 2019

  
www.epri.com

© 2019 Electric Power Research Institute, Inc. All rights reserved.



Agenda

- Overview and Current DCFC Approaches
- DCaaS Applications
- Architecture
 - One-to-on vs common bus
 - Diode Rectifier vs Self-Commutated
 - >2.5MW site distribution (high current, multiple power strings, medium voltage, ...)
- Technology Roadmap
- SPN

Technical Design – System Level

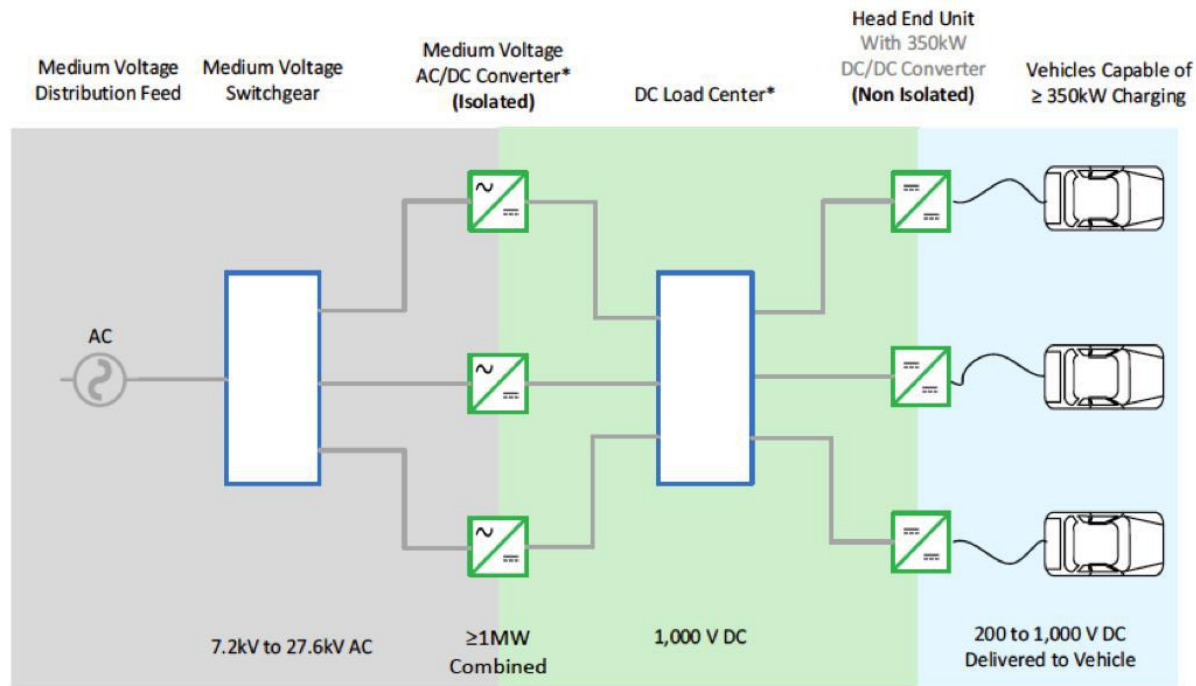

AC and DC Approaches for DC Fast Charging

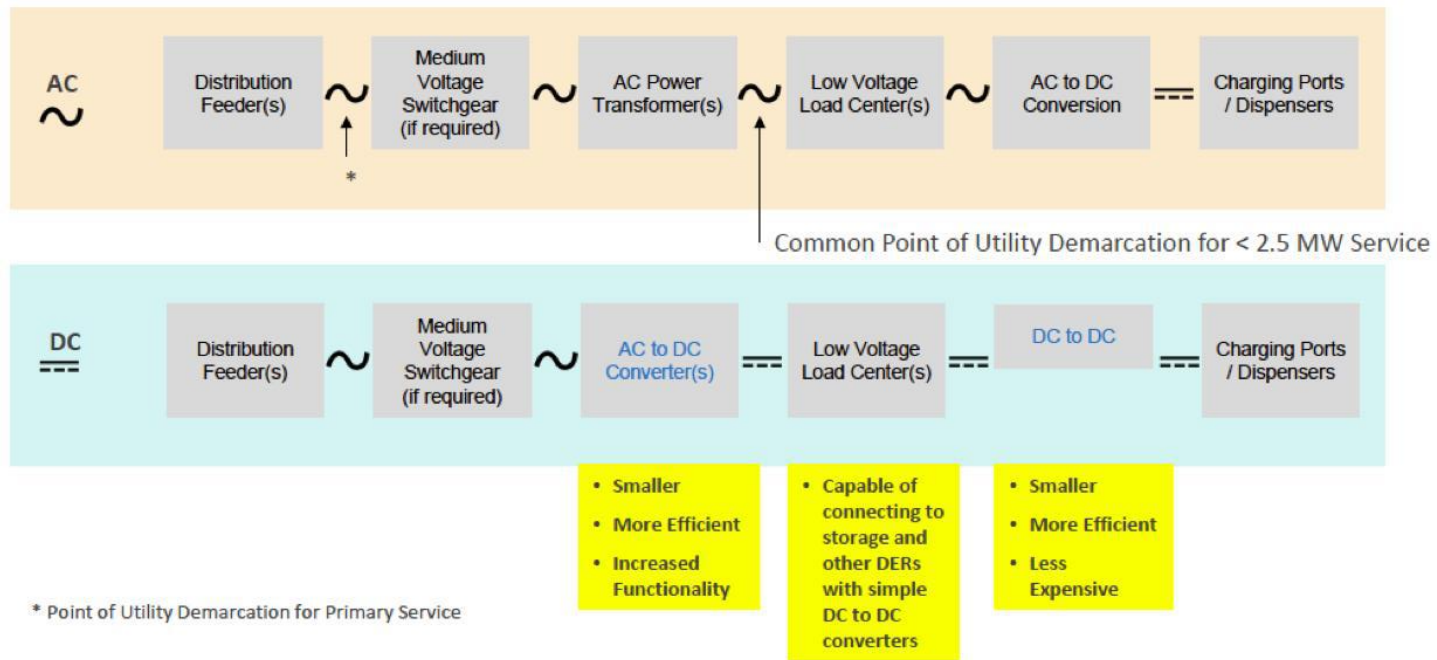

Potential Transit Applications

- Pilot bus depots for 6-12 transit buses (Short-term high priority)
- Bus Depot for 100+ transit buses (Short-term desire, but some compromises in short-term)
- On-Route bus charging (AC short-term, but DC important for battery storage integration)
- Drayage Vehicles
- Long Haul Corridor Charging
- Tractor Trailer depots
- Collocating light duty vehicle charging with other applications
- Logistics Parcel and Distribution Depots (Parcel delivery vehicles and Tractor Trailers)
- Micro Grid applications for resiliency and independence
- Military Applications
- Light Duty Interstate corridor charging
- Workplace charging
- Taxi / Mobility Depots
- Fleet Depots
- Hydrogen Production facilities
- ...

450 kW AC to DC Power Conversion at Base of Each Pantograph



Electrical Equipment Enclosed in Building Above Buses

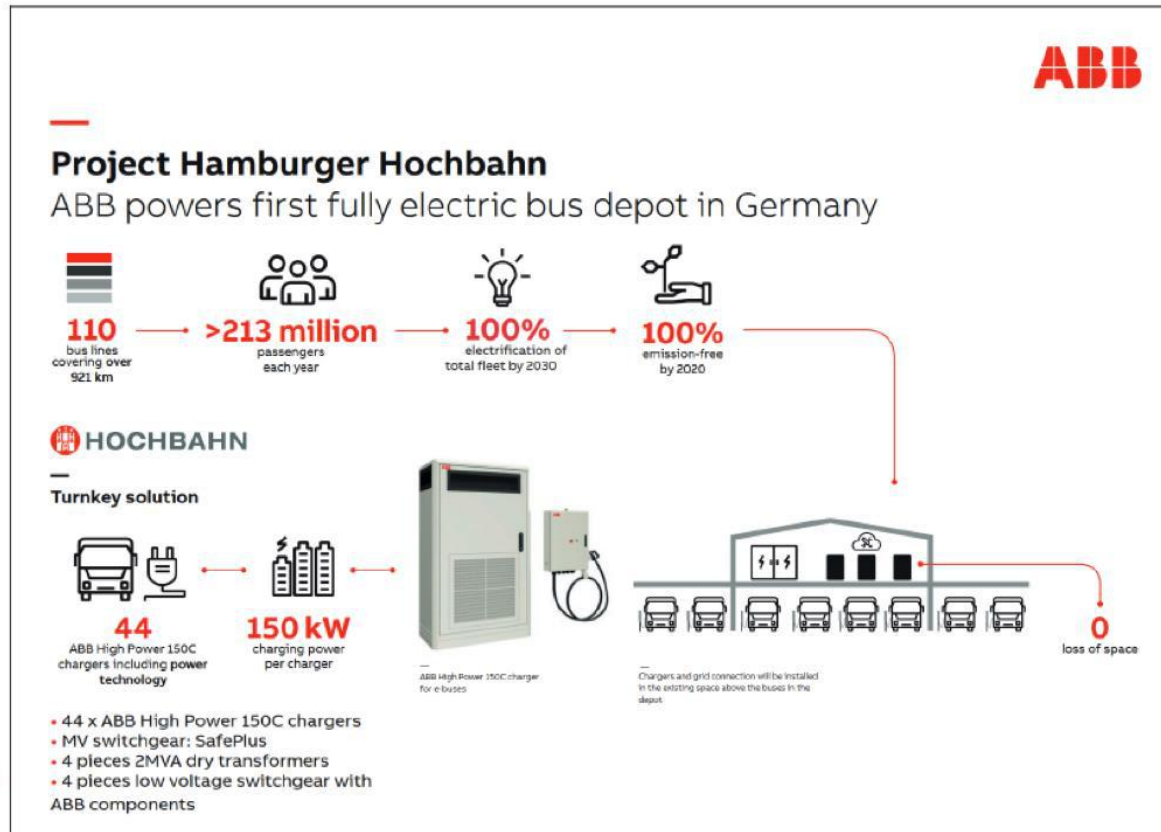

AC Input Power Cabinets for DC Fast Charging (450kW and 30kW)



Opportunity Charger
450 kW

UL

Specifications

General	Charger
Environment operating	Indoor/Outdoor
Temperatures	-4 to 122 °F (optional to -22 °F)
Charging standard	SAE J3105*
Compliance and safety	UL 2202* / UL2231*
Output DC voltage range	460 - 800 V
Rated DC output power	450 kW
Rated DC output current	300 A, bidirectional
Input connections	3P + PE
Input power rating; full load / idle	480 kVA / 500 VA
Input AC line-line voltage range	480 V +/-10%
Input AC phase current; maximum / fused	587 / 700 A, inrush current limited
Power factor, THD	> 0.95, < 5%
Power conversion efficiency	> 96%
Dielectric withstand	3000 V RMS
Network connection	3/4G modem / OCPP
Protection	NEMA 3R / IK10
Operational noise level	<55 dB(A) @ 6.56 ft
System weight	881.49 lbs

* Under development

Dimensions

Line	Block
H: 2300	H: 2400
W: 4500	W: 3400
D: 800	D: 1600

Power Curve



V min = 460 V DC
P max = 450 kW

Depot Charger

Fast DC 2x30 kW

CE





Specifications

General	Charger
Environment operating	Indoor/Outdoor
Temperature	-20 to 40 °C (optional to -30 °C)
Charging standard	IEC61851-1/23/24 / DIN 70121 / ISO15118
Compliance and safety	CE / EN 55011 / IEC61000-6-2
Output DC voltage range	460 - 800 V
Rated DC output power	2 outputs; each 30 kW
Rated DC output current	2 outputs; each 60 A, bidirectional
Input connections	3P + PE + N (5G35)
Input power rating; full load / idle	65 kVA / 50 VA
Input AC line-line voltage range	400 V +/-10%
Input AC phase current; maximum / fused	94 / 100 A, inrush current limited
Power factor, THD	> 0.95, < 3%
Power conversion efficiency	> 96%
Dielectric withstand	3000 V RMS
Network connection	GPRS / 3G modem / OCPP / OSCP
Protection	IP54 / IK10
Operational noise level	<55 dB(A) @ 1 m
System weight	650 kg

Dimensions

H: 2300 mm
W: 800 mm
D: 600 mm



Power Curve

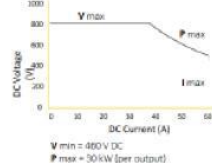

V min = 400 V DC
P max = 30 kW (per output)

Potential Converter and Head Unit Combinations

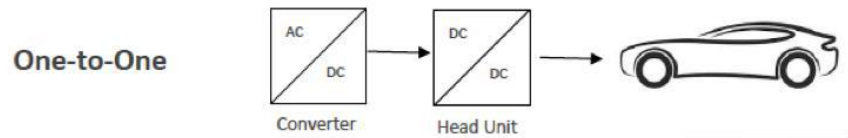

Today's Approach

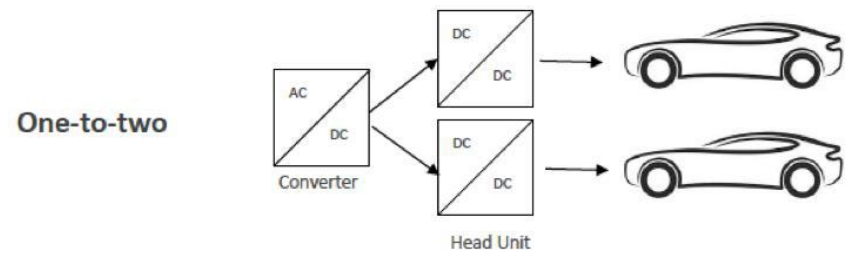

May be possible today with non-isolated Head Units

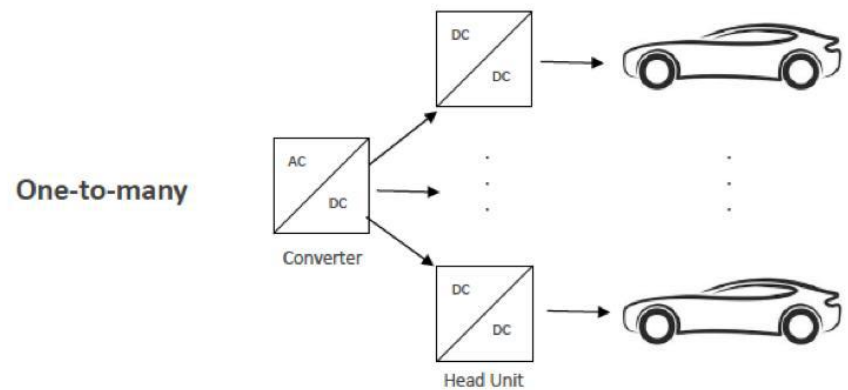

Requires isolated Head Units

Benefits:

- Converter can be sized to diversified load
- Site level DER integration at DC

Medium Voltage: Diode Rectifier vs Self-Commutated

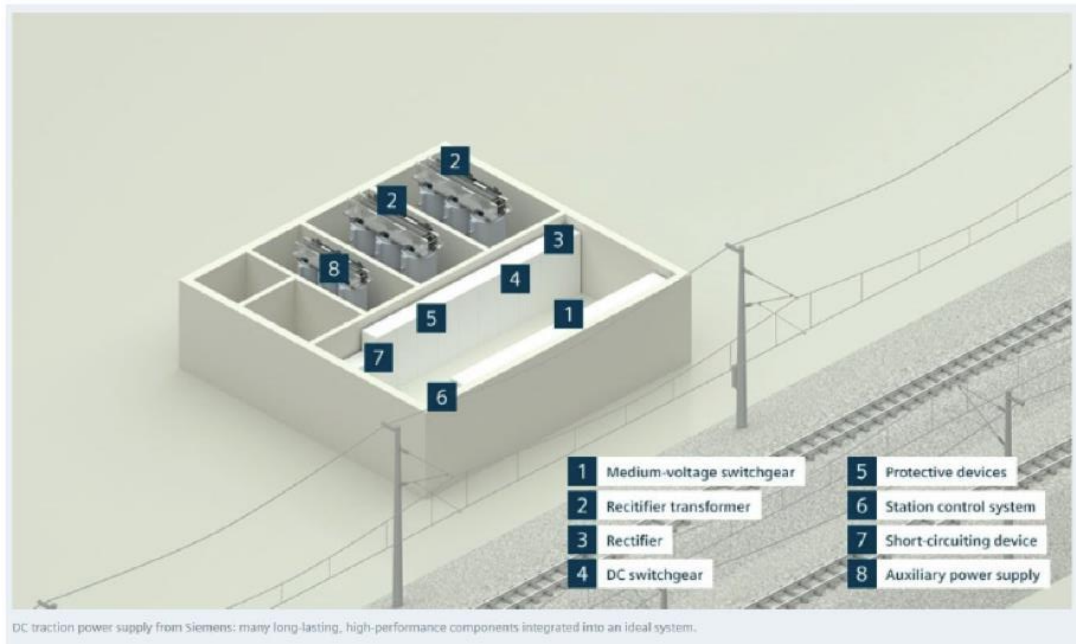

Diode Rectifier

- Uni-Directional
- Ripple and Harmonics
- High Fault Currents
- Large
- † Commercially Available

Self-Commutated

- † Bi-directional possible
- † Low ripple and harmonics
- † Limited Fault Currents
- Not Commercially Available

Electrical Requirements For Charging at an Electric Bus Depot

	Pilot Project Experience	Projects Beyond Pilots
Charging Characteristics at Sites	50 – 500 kW, less than 10 ports	50 – 500 kW+, 100 ports or more
Site Load	< 2.5 MW	> 10 MW
On-Site Power Distribution	<ul style="list-style-type: none"> • 480 V 3Ø • Single Bus Configuration 	<ul style="list-style-type: none"> • Multiple power strings • 480 V 3Ø AC or 1,000 V DC
Utility Service	<ul style="list-style-type: none"> • Secondary metered service • Typically able to connect to 11kV and above distribution feeders if circuit is near site 	<ul style="list-style-type: none"> • Multiple distribution feeders may be required or a new substation • DC as-a-Service potential • Opportunity for new system integration strategies (reliability, efficiency, space, cost savings, grid integration, ...)

The Power Threshold: Impacts to 480V Traditional and DCaaS Approaches

Connected KW

Charger Head Power Rating	Number of Charging Heads					
	5	10	20	40	80	160
50	250	500	1,000	2,000	4,000	8,000
100	500	1,000	2,000	4,000	8,000	16,000
150	750	1,500	3,000	6,000	12,000	24,000
200	1,000	2,000	4,000	8,000	16,000	32,000
250	1,250	2,500	5,000	10,000	20,000	40,000
300	1,500	3,000	6,000	12,000	24,000	48,000
350	1,750	3,500	7,000	14,000	28,000	56,000
400	2,000	4,000	8,000	16,000	32,000	64,000
450	2,250	4,500	9,000	18,000	36,000	72,000
500	2,500	5,000	10,000	20,000	40,000	80,000

Above 2.5MW: High Current, Multiple Power Strings, or Intermediate Medium Voltage on Customer Site

Single-Multi Output Mechanized Coupler Charging Systems Innovation, DC Distribution

- Opportunity to create a standard/convention for interconnection of building blocks of DC distribution system and modular dispenser systems for lowest maintenance costs and flexible load control leveraging new/existing DC power conversion/storage/connection systems

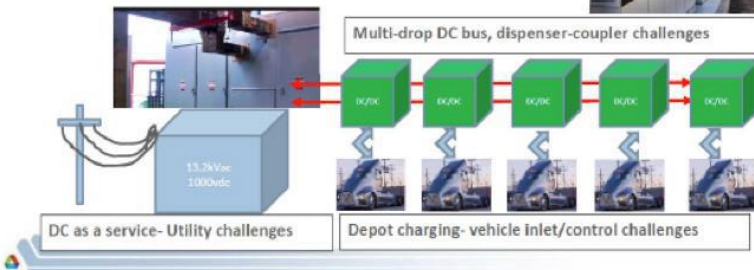

1000A-10,000A Shared DC Bus Example Sizing

- Basic assumption for MW level EV charging is $\sim 1000\text{vdc}$ bus voltage, leading to 1000A charging currents; per vehicle, up to 10 vehicles in parallel on bus section
- Example (from web photo, presumably data center feed) shows two parallel bus bars (blue), estimated 2"x10" with 5 parallel connections on each pole, routed to the room/device above on $\sim 4/0$ insulated cables ($\sim 1000\text{A}+$); feeding two devices above
- Mounting includes plastic shielding, \sim nylon clamping blocks, red standoffs below



Skid Mounted Substation Approach in Solar Industry

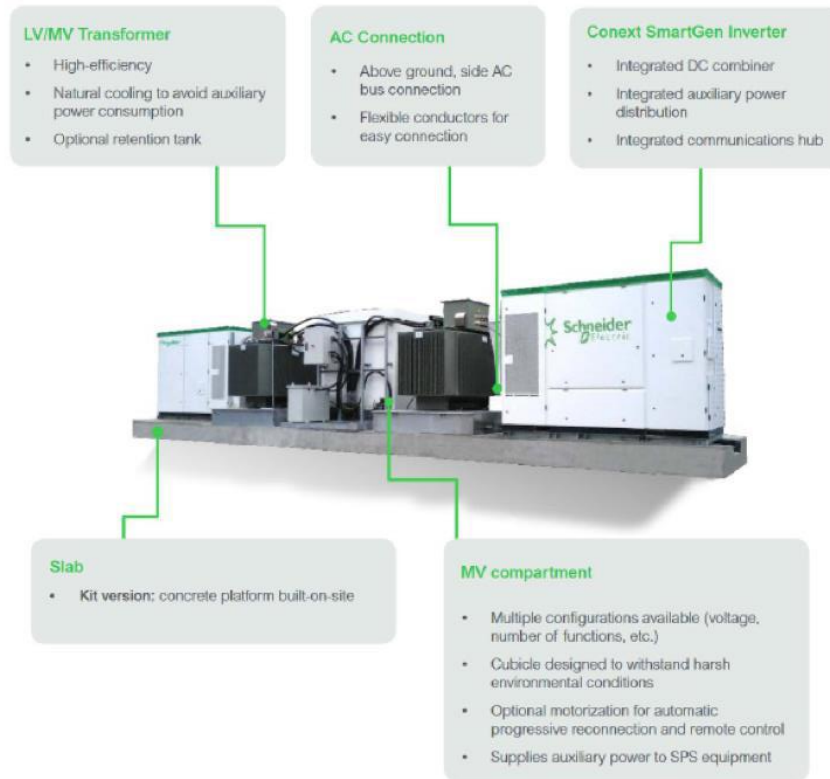

Technologies Needed

- ✓ <13.8kV Medium Voltage Converter (DOE supported project)
 - >13.8kV Medium Voltage Converter
- ✓ Isolated Head Unit (DOE supported project)
 - Non-Isolated Head Unit
 - DC-to-DC DER Converter (non-isolated or isolated)
- ✓ Circuit Breakers (from solar or transit)
 - Solid State Circuit Breakers
 - DC Metering
 - DC Load Center Controller
 - Modeling Tool for DCFC at large sites
 - Standards
 - ...

Engagement Roadmap With EPRI

DOE Funded DCaaS for XFC

- Develop Medium voltage AC-DC Conversion Technology
- Laboratory Testing
- Demonstration Site Deployment
- Coordination with other DOE funded projects

Foundational Elements for XFC DCaaS (supplemental)

- Specifications for AC portion of system
- DC standards needs
- Technical requirements, use cases and cost-benefit for regulatory support
- Evaluate economic implications

Infrastructure Working Council & Bus and Truck

- Provide updates on EPRI projects
- Presentations on related projects
- Presentations on standards activities

Other Stakeholder Processes

- Participation in related stakeholder activities
- ANL/DOE MW+ stakeholder group
- DC metering
- High Power Connector standards work
- Others ...

Additional Projects

- EPRI is interested in advancing additional projects
- Energy Storage
- Hydrogen / Fuel Cells
- Solar
- Distribution system integration
- DC micro grid control techniques
- Additional use cases

Foundational Elements for DCaaS

- With various entities developing a range of XFC technologies in this formative stage, a common set of requirements, standards, approaches, and techniques is needed to achieve interoperability of the devices included in these systems. EPRI has proposed a project to establish the foundational technical transfer activities with leading utilities to:
 - Identify the technical and packaging requirements for the DC power distribution and grid connection
 - Identify the standards needs for the DC portion of the XFC system
 - Advance the development of technical requirements for regulatory support
 - Evaluate the economic implications of the XFC approach
- Successfully establishing these foundational elements will further the effort to achieve grid integration of XFC in an interoperable, modular, and scalable manner. It will also create a novel technology pathway that could also enable DC as-a-Service and renewable integration approaches.
- For more information or to participate with EPRI on its project, contact EPRI Technical Executive Watson Collins, wcollins@epri.com.

State-of-the-Art Transit Substation Opportunities

- Modularity / constructability
- Equipment sizing (data validation, charging strategies, split of opportunity vs depot charging, ...)
- Space requirements for substation and conversion equipment
- Reliability approaches (off-site & on-site, reliability assessments, equipment transient performance testing, electrical bus designs, ...)
- Load management capabilities (charge management, EMS/SCADA systems, machine learning, ...)
- Energy storage and other distributed energy resource integration capabilities
- Onsite power distribution and conversion strategy (where does the AC to DC conversion take place?)
- Costs (installation, maintenance and operating)
- Flexibility to be repurposed for other applications (hydrogen electrolysis, reversible fuel cells, ...)



Together...Shaping the Future of Electricity

